

AAE Model No. AC-12
All Purpose Carrier - 6' x 12'

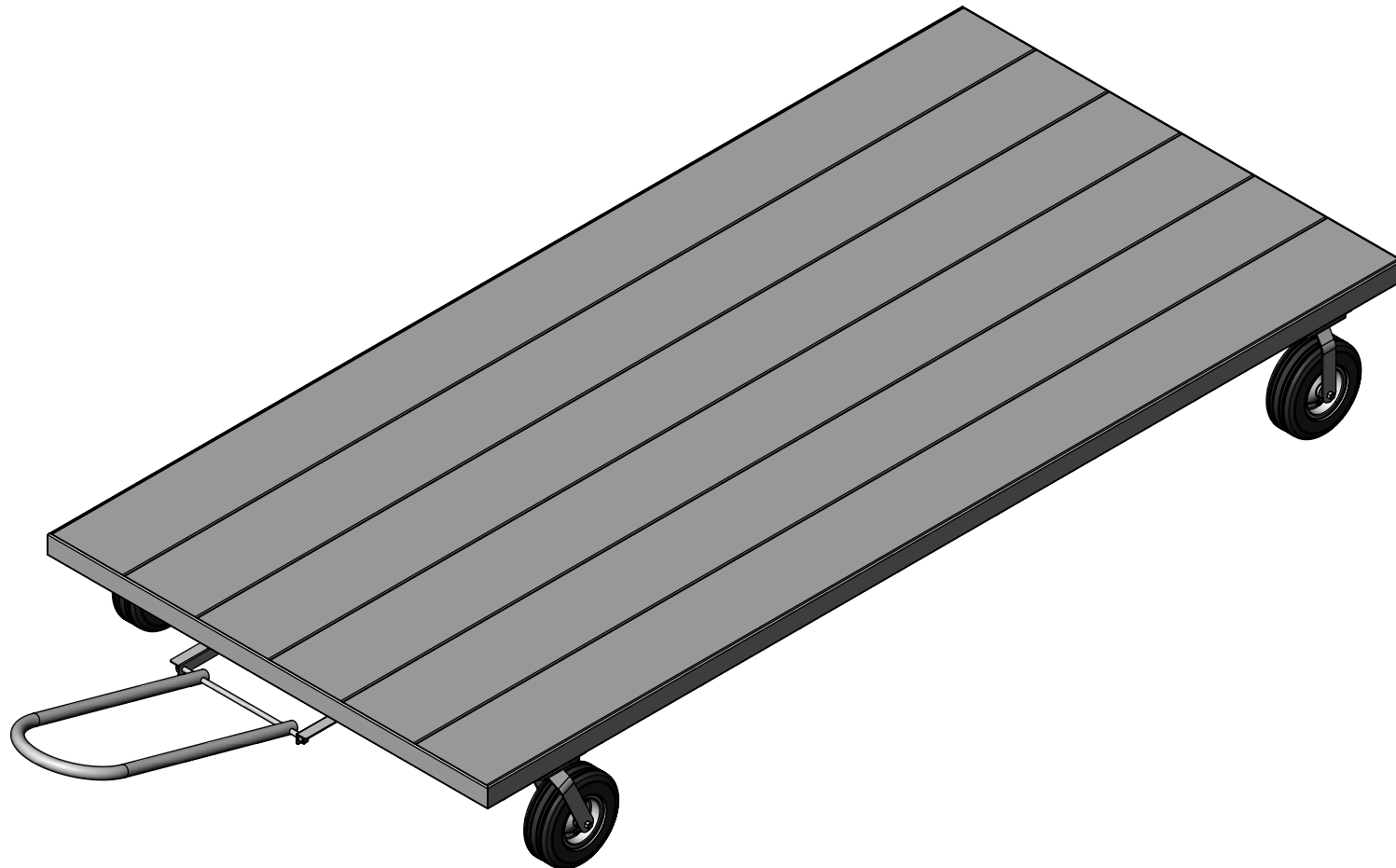

Aluminum Athletic Equipment
1000 Enterprise Drive, Royersford, PA 19468
Toll Free: (800) 523-5471 Fax: (610) 825-2378
www.AAEsports.com

AC-12A Specifications (6' x 12')

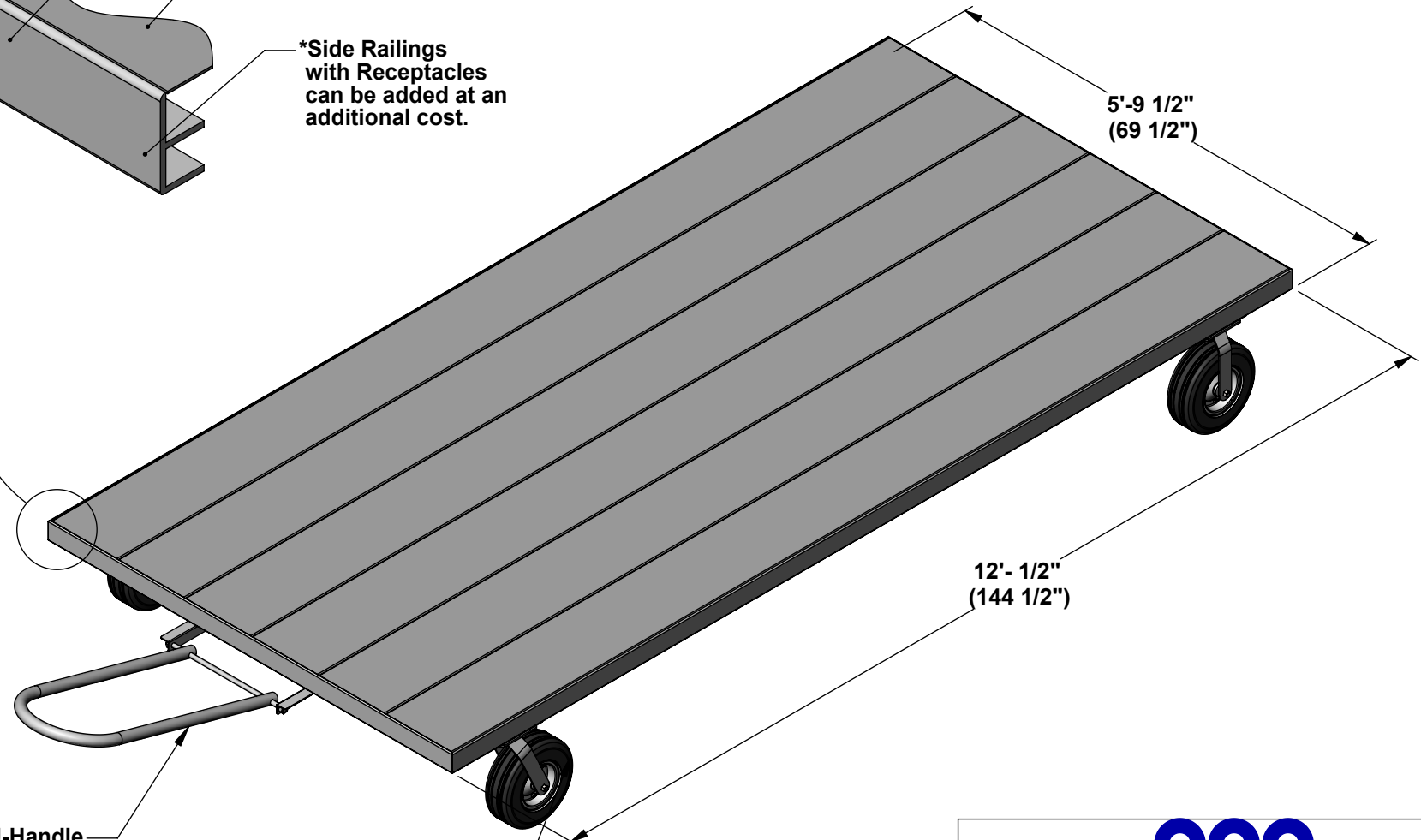
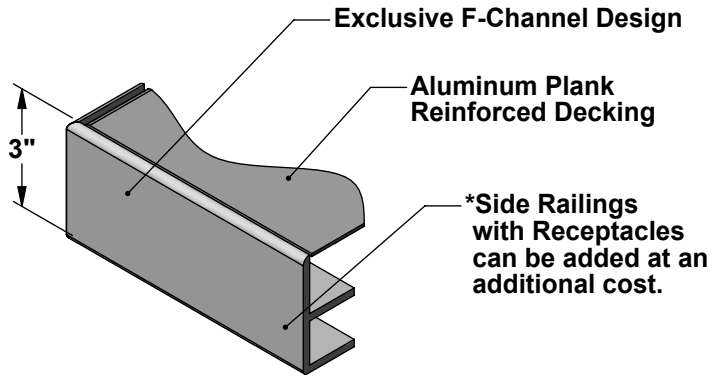

Aluminum U-Handle
(also available with Hitch Coupler)

12" Swivel Casters (Front)
12" Rigid Casters (Rear)

Overall Weight = 230 lbs.



Aluminum Athletic Equipment
1000 Enterprise Drive, Royersford, PA 19468
Toll Free: (800) 523-5471 Fax: (610) 825-2378
www.AAEsports.com

DESCRIPTION		
AC-12A - All-Purpose Carrier - Specifications		
NOTE: 6' x 12' Nominal Dimension		
MODEL: AC-12A	CATEGORY: CUSTOMER	DATE: 12/24/03
DWN. BY: TAD	CAD FILE: AC-12A - Specifications	DWG. NO. AC-12A-C-001