

AAE Model No. AC-12AS
All Purpose Carrier with Side Rails - 6' x 12'

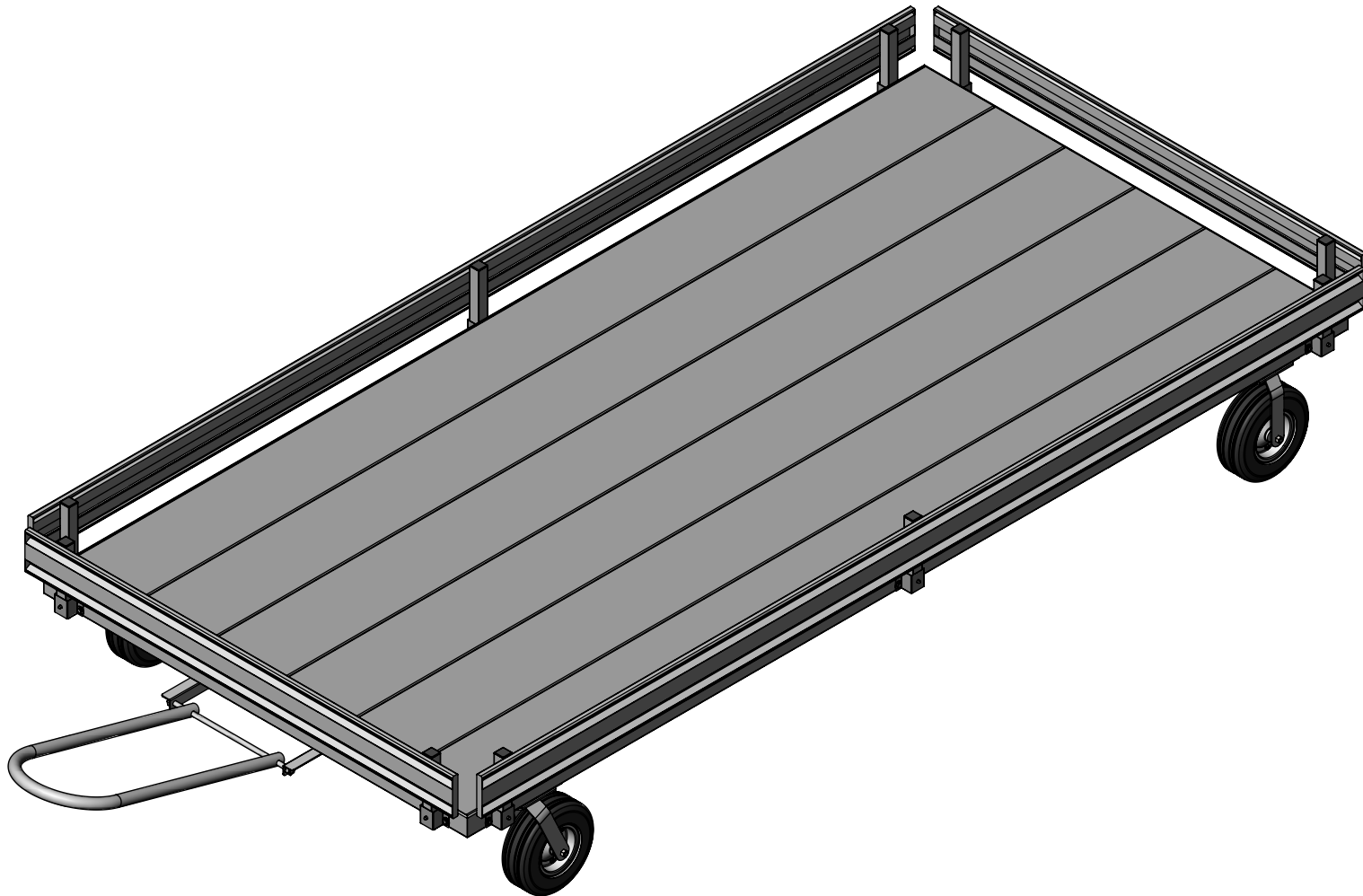

Aluminum Athletic Equipment
1000 Enterprise Drive, Royersford, PA 19468
Toll Free: (800) 523-5471 Fax: (610) 825-2378
www.AAEsports.com

AC-12AS

Specifications

(6' x 12' w/ Side Rails)

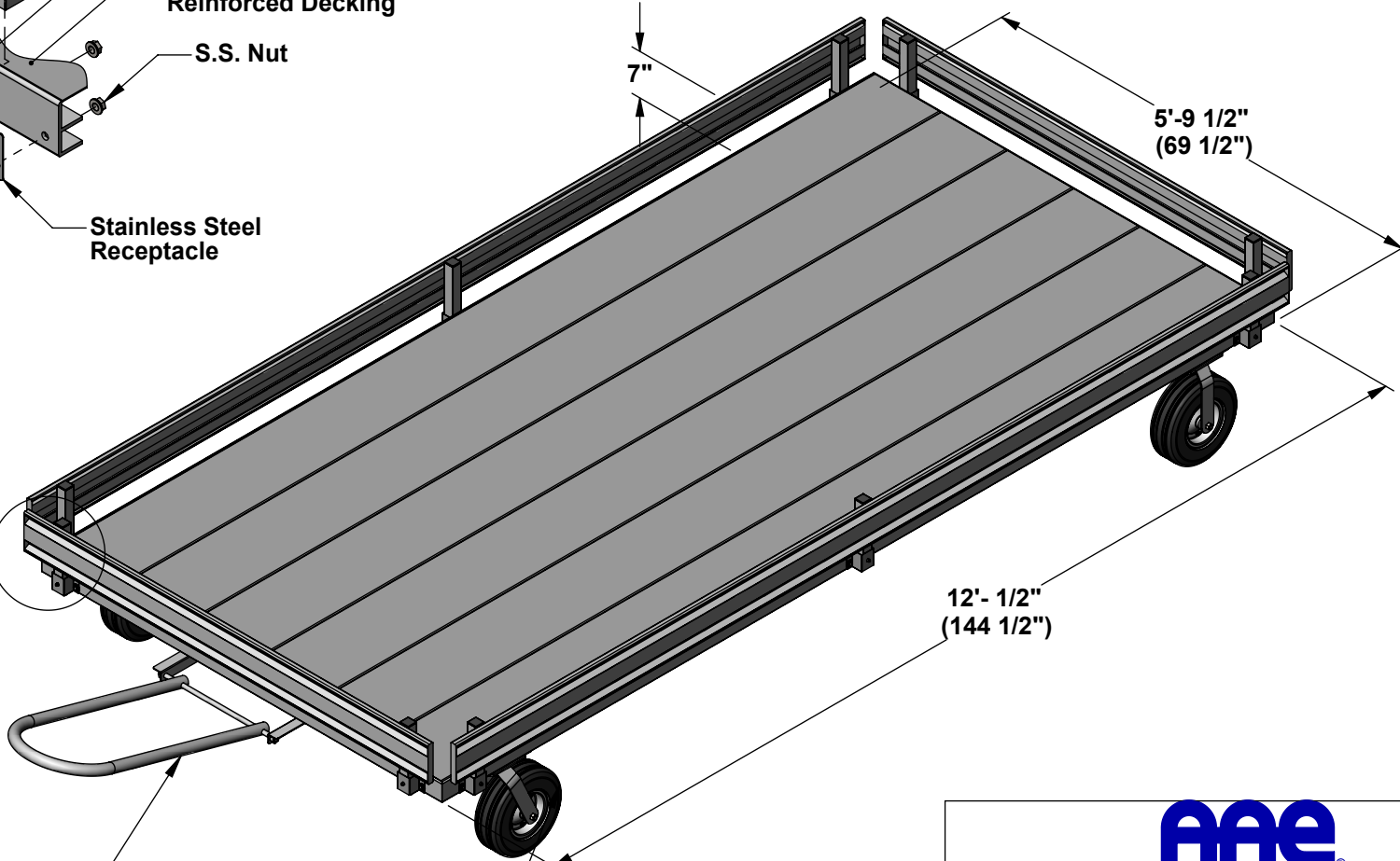
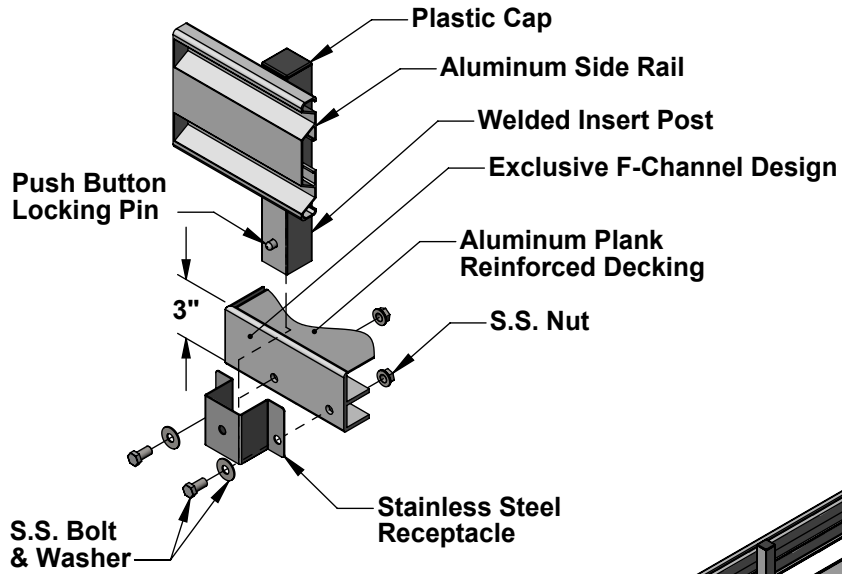

Aluminum U-Handle
(also available with Hitch Coupler)

12" Swivel Casters (Front)
12" Rigid Casters (Rear)

Overall Weight = 280 lbs.



Aluminum Athletic Equipment
1000 Enterprise Drive, Royersford, PA 19468
Toll Free: (800) 523-5471 Fax: (610) 825-2378
www.AAEsports.com

DESCRIPTION		
AC-12AS - All-Purpose Carrier - Specifications		
NOTE: 6' x 12' Nominal Dimension with Side Rails		
MODEL:	CATEGORY:	DATE:
AC-12AS	CUSTOMER	12/24/03
DWN. BY:	CAD FILE:	DWG. NO.
TAD	AC-12AS - Specifications	AC-12AS-C-001