

Baseball Backstopper System - 25' High Cable Design - 4 Poles

D
C
B
A

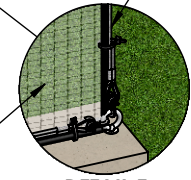

Note: Not all drawings to scale

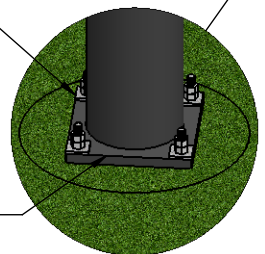
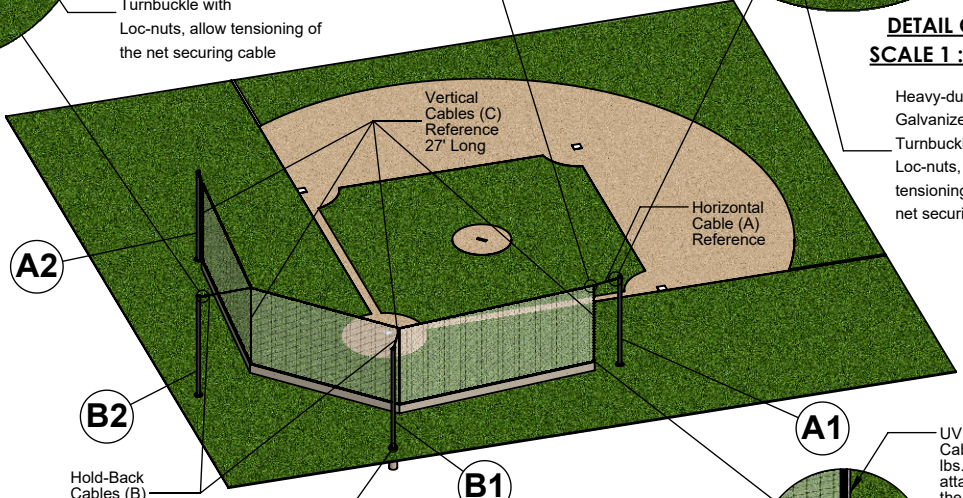
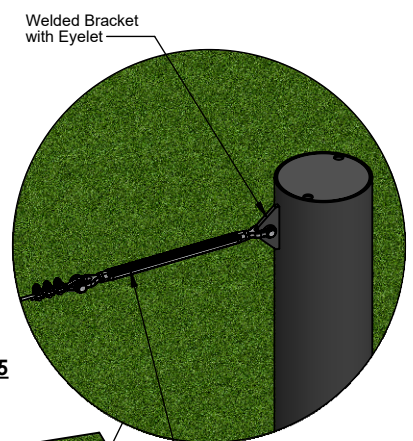
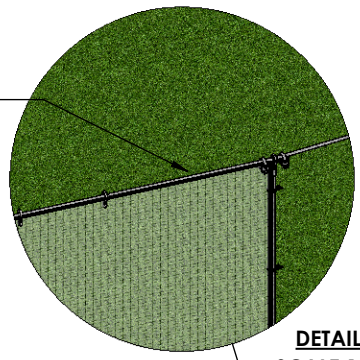
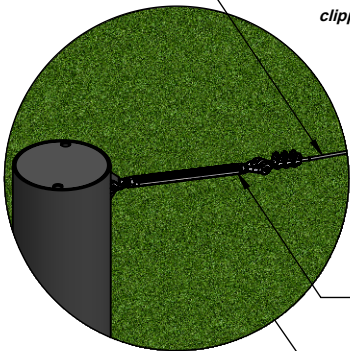
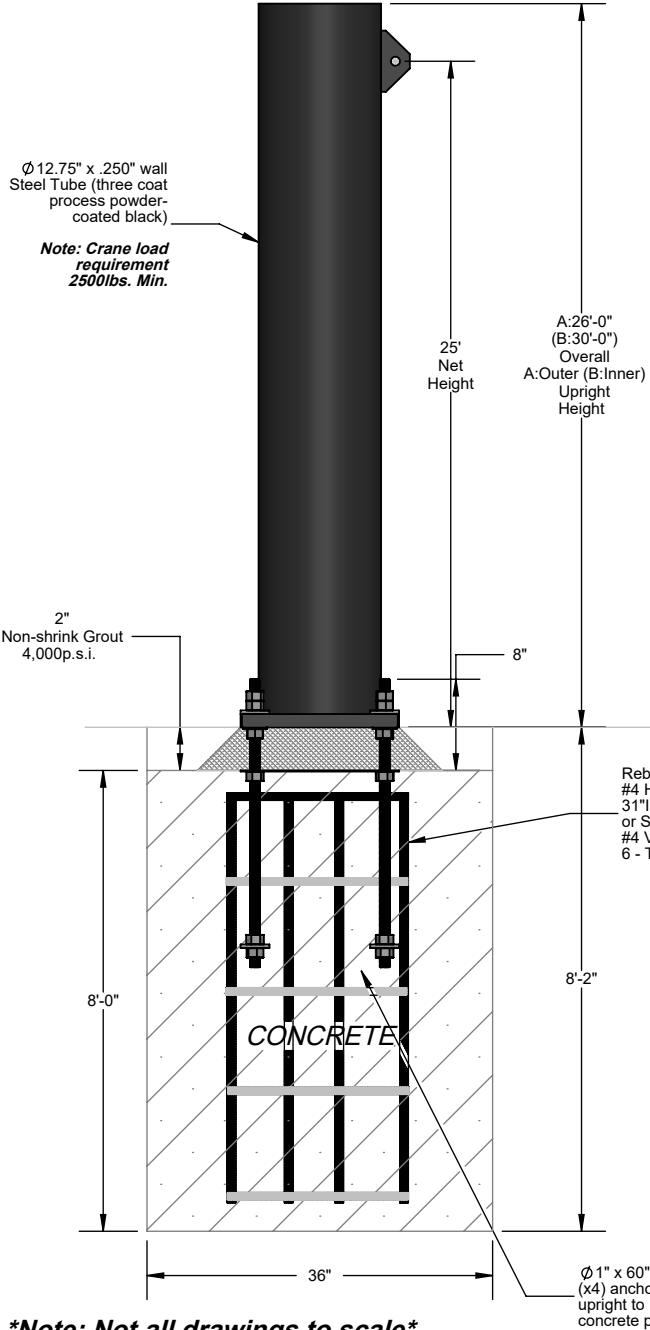

Aluminum Athletic Equipment
1000 Enterprise Drive, Royersford, PA 19468
Toll Free: (800) 523-5471 Fax: (610) 825-2378
www.AAEsports.com

DESCRIPTION: Baseball Backstopper System - 25' High - Cable Design		
NOTE: System Specifications		
MODEL: BBS-25-CD/12	CATEGORY: CUSTOMER	DATE: 2/8/2016
DWN. BY: N.R.	CAD FILE: BBS-25-CD_12 - Specifications	DWG. NO. BBS-CD/12-001

Baseball Backstopper System Cable Design - 4 Poles Layout Form

Project Name:
Zip Code:

Notes:

1. Minimum 10' space is required between end of net and post.
2. List System Net Length Sections A, B & C.

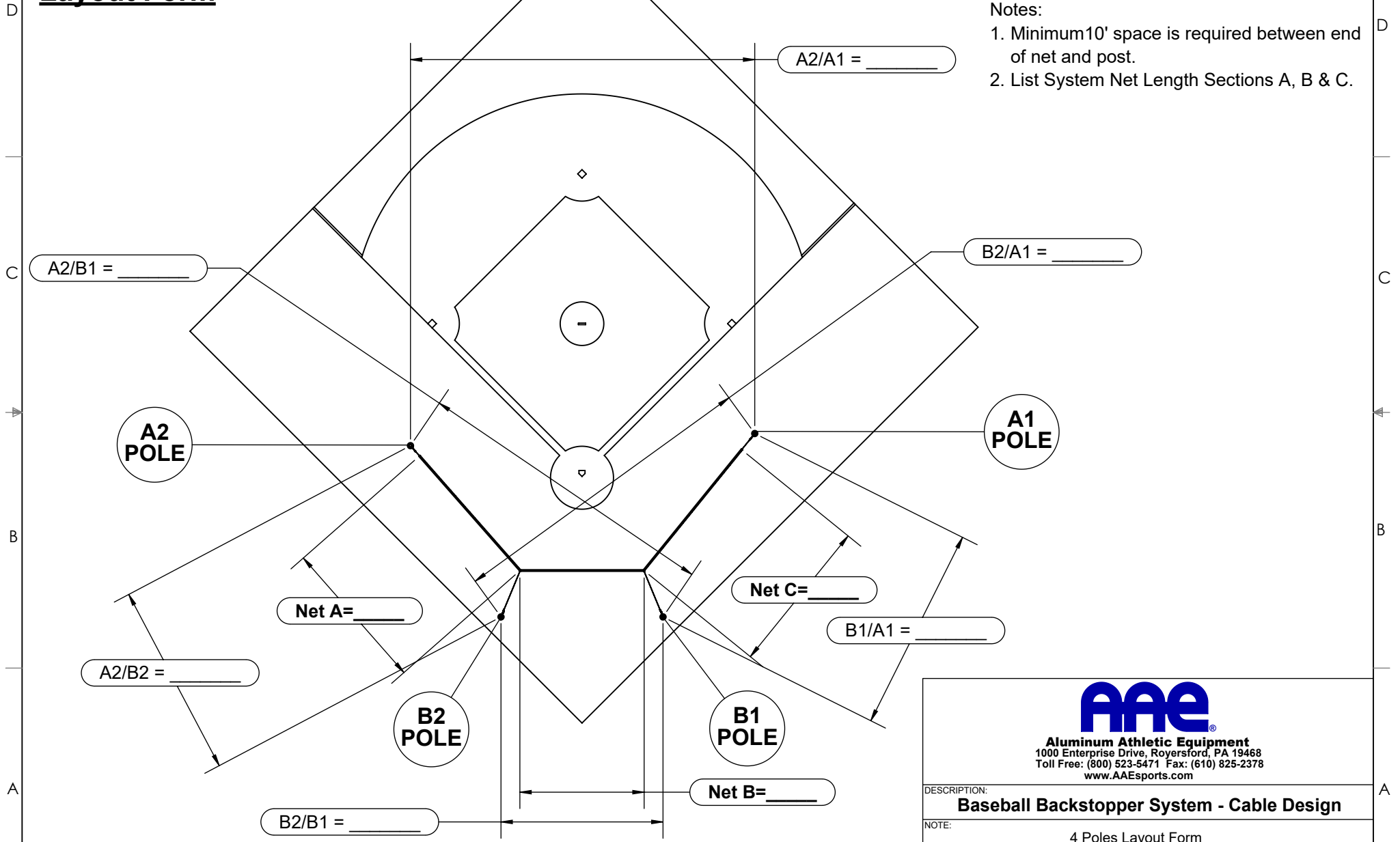

Please fill in all dimensions in the circled areas above.



Aluminum Athletic Equipment
1000 Enterprise Drive, Royersford, PA 19468
Toll Free: (800) 523-5471 Fax: (610) 825-2378
www.AAEsports.com

DESCRIPTION: Baseball Backstopper System - Cable Design		
NOTE: 4 Poles Layout Form		
MODEL: BBS-25-CD/12	CATEGORY: CUSTOMER	DATE: 2/8/16
DWN. BY: N.R.	CAD FILE: BBS-25-CD_12 - Specifications	DWG. NO. BBS-CD/12-002

Baseball Backstopper System - 25' High Cable Design - 4 Poles

D

C

B

A

D

C

B

A

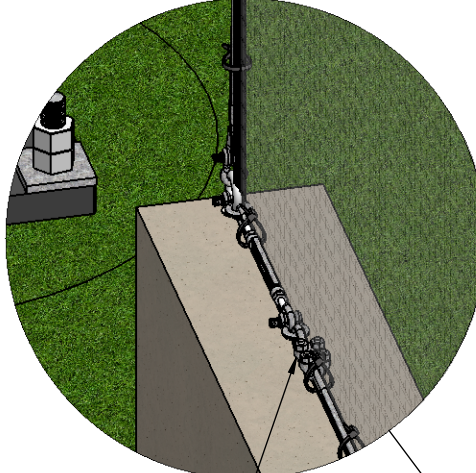

Rear Hold-back
Tension Cable
end loop
assembly.
Note:
*Orientation of
clamps, U-bolt
must be on
cut lead side.*

Note: to
ensure
optimum
clamp grip,
vinyl jacketing
must be
stripped from
all cable loop
ends prior to
installing
clamps .

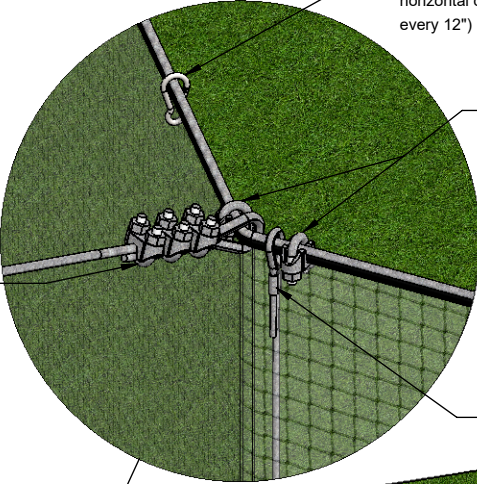

Stainless steel pear clips
attach the net to the upper
horizontal cable. (spaced
every 12")

Cable Clamps, used
to ensure placement
of support cables.
(typical for all vertical
support cables)

Vertical
Support Cable,
End loop
assembly.
Note:
Preassembled

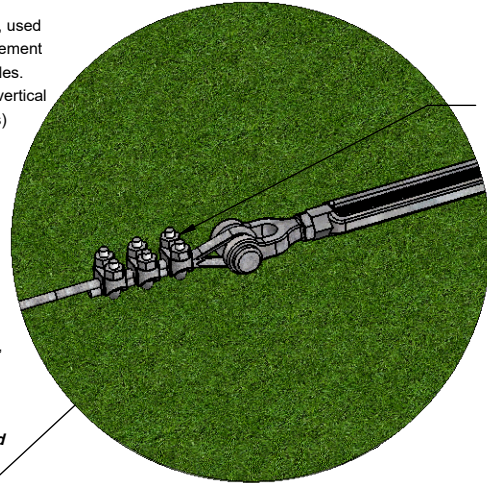

Upper Tension
Cable end loop assembly.
(typical for both ends)
**Note: Orientation of
clamps, U-bolt must be
on cut lead side.**

Note: to ensure optimum
clamp grip, vinyl
jacketing must be
stripped from all cable
loop ends prior to
installing clamps .

Lower Tension
Cable Clamped
end loop
assembly.
Note: to ensure
optimum clamp grip,
vinyl jacketing must
be stripped from all
cable loop ends prior
to installing clamps .

Vertical cable end loop
assembly.
(lower loop assembly
secured to eyebolts w/
anchor shackles)

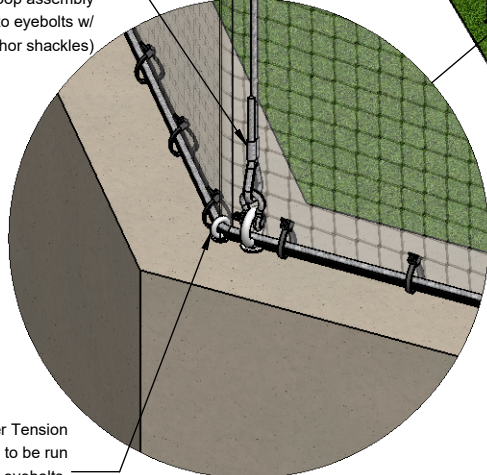

Lower Tension
cable to be run
through eyebolts.
(spaced approx.
4ft on center.)

Lower Tension Cable
Crimped end loop
assembly.
Note: Preassembled

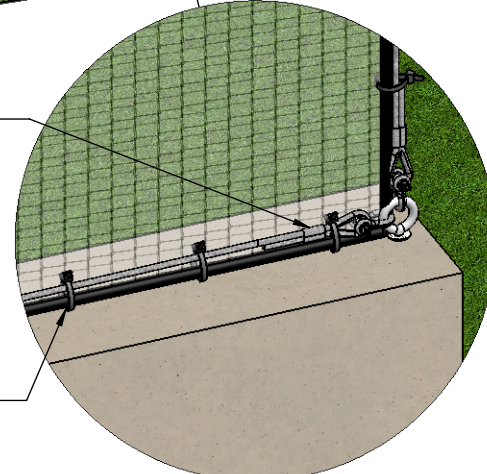

Cable ties used to secure
bottom of net to lower
horizontal support cable,
spacing approximately 6".

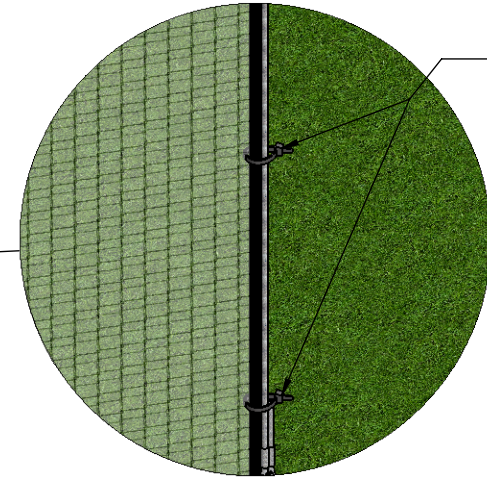

Nylon tie wraps
attach the net to
the lower and
vertical end cables
(spaced approx
every 12" on
vertical cable and
6" on lower
horizontal cable)

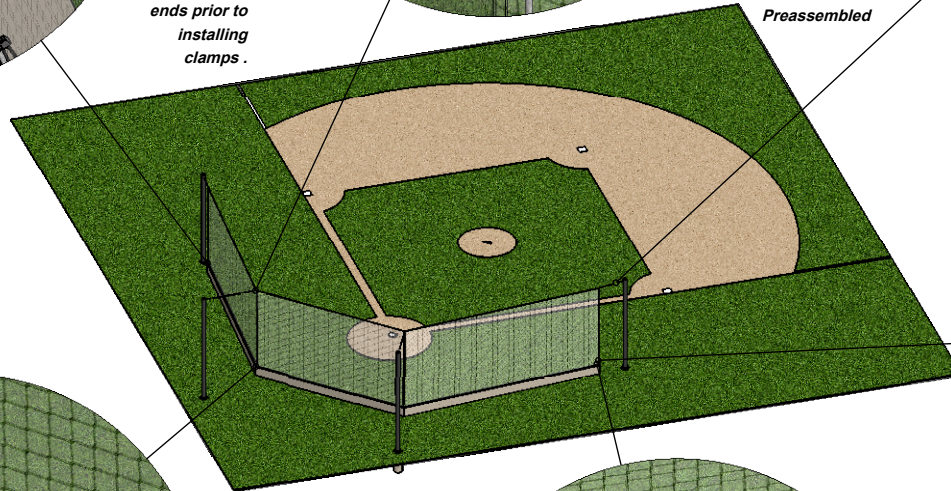

Note: Not all drawings to scale



Aluminum Athletic Equipment
1000 Enterprise Drive, Royersford, PA 19468
Toll Free: (800) 523-5471 Fax: (610) 825-2378
www.AAEsports.com

DESCRIPTION: Baseball Backstopper System - 25' High - Cable Design		
NOTE: System Specifications		
MODEL: BBS-25-CD/12	CATEGORY: CUSTOMER	DATE: 2/8/2016
DWN. BY: N.R.	CAD FILE: BBS-25-CD_12 - Specifications	DWG. NO. BBS-CD/12-003

6

5

4

3

2

1

BBS-25-CD/12
BASEBALL BACKSTOP SYSTEM – CABLE DESIGN
INSTALLATION, ASSEMBLY AND USE INSTRUCTIONS

PRIOR TO INSTALLATION

1. Check local codes to verify if a Professional Engineer wet stamp is required in your state by a licensed engineer within the state. If so, please contact AAE to assist in this process.
2. Proper location for placement of your cable designed tensioned system should be marked off and a local 1 call should be made and all utilities marked prior to excavation. Use AAE'S Layout Form labeled **DWG. NO. BBS-CD/12-001** to provide the required distances of poles and help verify that the system is properly designed and there are no changes needed. Center system off the home plate and the pitcher's mound. Consult architect's drawings for proper footing locations and location with respect to the backstop wall.
3. Prior to installing system all soil types and compactions should be considered to meet minimum requirements.
4. Please call AAE and discuss prior to purchasing a system and to verify this system is proper for your project.

INSTALLING FOUNDATION TEMPLATES

1. If net is being installed over top a wall AAE should be made aware to accommodate the proper hardware to install. Also if attaching to the top of a fence custom hardware will be needed.
2. Locate proper location for placement of BBS-25-CD/12. Center system off the homeplate and the pitcher's mound. Consult architect's drawings for proper foundation locations and location with respect to the wall. Outside 1ST BASE & 3RD BASE line poles should be aligned with the wall or fence in order for the net to fall at the intersecting point below the Upper Main Tension Cable.
3. AAE does not recommend use of a Sonotube with this products installation, however galvanized steel corrugated is acceptable.
4. Install per DWG. NO. BBS-CD/12-001 and follow engineered layout of rebar.
5. As the concrete cures, constantly check that the top templates are plumb and the threaded studs are level with at least 8" of threaded stud above the top of concrete.
6. Build wall according to architect's specifications.
7. Allow ample time (4-5 days) for concrete to set before erecting poles and tensioning system.

BBS-25-CD/12
BASEBALL BACKSTOP SYSTEM – CABLE DESIGN
INSTALLATION, ASSEMBLY AND USE INSTRUCTIONS

POLE ERECTION:

1. Refer to DWG. NO. BBS-CD/12-001 & BBS-CD/12-003 for referencing with the following steps.
2. Once footings have cured, a crane will be required to position the 26' and 30' long poles. Pole weights vary from 1100lbs. to 1350lbs.
3. Make sure to check leveling nuts and verify that they are positioned no more than 2" above the concrete foundation prior to positioning.
4. **IMPORTANT!** When positioning pole mounting plates over four (4) j-bolts, make sure not to damage j-bolt threads, which could cause irreversible damage.
5. The 26' height poles (A1 & A2) are to be positioned on the outer foundations 1st & 3rd base lines, with the welded brackets facing in the direction of home plate (or ultimately the line of the backstop net).
6. The 30' height poles (B1 & B2) are to be positioned on the back corner foundation locations with the brackets facing in the direction of the pitcher's mound.
7. Use 3/8" thick galvanized plate washers with two (2) galvanized steel nuts to properly secure poles to foundation j-bolts.
8. Once poles are leveled and set in proper position a 4,000p.s.i. non-shrink grout should be used to fill the 2" gap between the bottom of the mounting plate and concrete foundation. Give proper time to allow it to set hard.

TENSIONING CABLES:

1. Be sure concrete **is fully cured** before attempting to tension cables.
2. Use a bucket lift to install hardware on pole brackets.
3. Layout the 3/8" diameter Upper Main Tension Cable (longest cable) and locate the center.
4. Measure half the distance of the HOMEPLATE net section length in both directions (Backstop "Net B") and use electrical tape to mark these locations. These are the locations which you will be attaching the 1/4" diameter Vertical Support Cables and the 3/8" diameter Rear Hold-Back Cables.
5. Measure the 1ST & 3RD BASE net section lengths from the now marked locations and use electrical tape to mark these locations. These are the locations which you will be attaching the outer Vertical Support Cables.
6. Now you can fasten the end loops of both the 3/8" diameter Hold-Back Cables & 1/4" Vertical Cables to the now marked locations on the 3/8" diameter Upper Main Tension via the anchor shackles. 1/2" (Larger) for the 3/8" Hold-Back Cable and

BBS-25-CD/12 BASEBALL BACKSTOP SYSTEM – CABLE DESIGN INSTALLATION, ASSEMBLY AND USE INSTRUCTIONS

1/4" (Smaller) for the 1/4" Vertical Cables.

7. Make up one end of Upper Main Tension Cable with 1/2" (Larger) galvanized loop thimble (1) and cable clamps (3). The clear vinyl coating on the cable must be cut with a box knife and removed from the cable end in order to allow the cable clamps to work properly.
8. ***Important:*** Please note that the orientation of the cable clamps is critical to functioning properly, the Saddle (forged body) must be tightened against the live (long) end of the cable (not the U-bolt)!

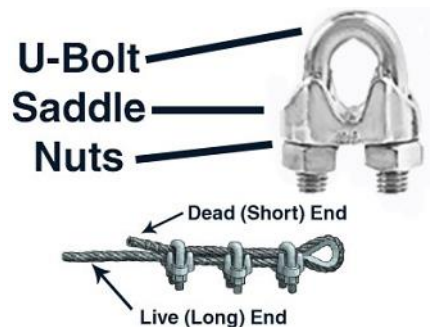

9. Attach loop end of the Upper Main Tension Cable to either (just one) the 1ST BASE or 3RD BASE line pole's (26') bracket via the 1/2" anchor shackle.
10. Then on the opposite 1ST BASE or 3RD BASE line pole, use a cable puller and a strap to wrap around the top of the pole and stretch the line out on the puller and temporarily clamp it to the Upper Main Tension Cable (unmade end).
11. Repeat Step No.10 to both 3/8" Hold-Back Cables on their corresponding rear corner poles (B1& B2) and use a cable puller and a strap to wrap around the top of each pole and stretch the line out on the puller and temporarily clamp it to the corresponding cables.
12. At this time you can begin pulling up the Upper Main Tension Cable via the attached cable puller. AAE can provide the finished cable lengths based on information provided in the Layout Form. This will assist in getting as close to the finished cable frame dimension as possible.
13. If not already completed install the 3/8" eyebolts with 3/8" double expansion shields at the four (4) Vertical Cables wall locations (net ends and back corners), which will maintain the proper height of the tensioned net system.
14. Once installed attach the corresponding Vertical Cables bottom loop ends via 1/4" anchor shackles at all four (4) eyebolt locations.
15. Now you can begin pulling up the Hold-Back Cables via the attached cable puller. AAE can provide the finished cable lengths based on information provided in the Layout Form. This will assist in getting as close to the finished cable frame dimension as possible.

BBS-25-CD/12
BASEBALL BACKSTOP SYSTEM – CABLE DESIGN
INSTALLATION, ASSEMBLY AND USE INSTRUCTIONS

16. Once the Vertical Cables are close to being plumb and level, you will need to attach the 7/8" (Large) turnbuckles to the two (2) 30' rear pole's (B1 & B2) welded bracket eyes via 1/2" anchor shackles (make sure turnbuckle is extended at this time to its full length).
17. Make up the end loops with the 3/8" galvanized thimble and cable clamps. *Keep in mind to remove the clear vinyl coating as well as keeping the cable clamps oriented properly as done in Step No. 8.*
18. Repeat Step No. 17 for the Upper Main Tension Cable (A1 or A2, depending which side you decided to locate the turnbuckle).
19. Once turnbuckles are all attached and cable clamps are tightened, you can now release the cable pullers and straps from the poles.
20. Tension the Upper Main Tension Cable & Hold-Back Cables till the Vertical Cables are tensioned and plumb.

ATTACHING BACKSTOP NET :

1. Lay nets on baseball field side and lay according to the proper lengths for the 1ST, HOME & 3RD BASE sections. Attach the vertical 1/4" borders every square on each net using the 120lbs. UV treated plastic cable ties. Snip ends off.
2. Using a bucket lift raise the top corner of the 1/4" rope border of the net to the intersection of the 1ST BASE Vertical Cable & Upper Main Tension Cable. Attach corner using an 8" plastic cable ties 120lbs. strength (larger) UV treated plastic cable ties.
Note: *Make sure net is on the STANDS side before preparing the next step.*
3. Next pull net taught and attach another plastic cable tie to the 1/4" rope border of the net at the intersecting point of the B1 Vertical Cable location and Upper Main Tension Cable.
4. Pull net taught and attach another plastic cable tie to the 1/4" rope border of the net at the intersecting point of the B2 Vertical Cable location and Upper Main Tension Cable.
5. Finally, pull net taught and attach another plastic cable tie to the 1/4" rope border of the net at the intersecting point of the 3RD BASE Vertical Cable location and Upper Main Tension Cable.
6. Now using the 2-1/2" stainless steel pear clips attach **FIRST to the net border** and space every 12" on center, **THEN attach to the Upper Main Tension Cable.**
Note: *It is a tight fit to get the clips on and very difficult to remove.*
7. Attach net borders to Vertical Cables using the 40lbs. strength (smaller) UV treated plastic cable ties every 12" on center.
8. Install intermediate 1/4" stainless steel eyebolts with double expansion shields

BBS-25-CD/12
BASEBALL BACKSTOP SYSTEM – CABLE DESIGN
INSTALLATION, ASSEMBLY AND USE INSTRUCTIONS

every 4' on center (space equally between 3/8" eyebolts for Vertical Cables and then run the bottom 1/4" wall cable through the eyes and make up cable and tension turnbuckle at one end.

9. Attach bottom net border to Wall Cable using the 40lbs. strength (smaller) UV treated plastic cable ties every 12" on center.
10. Inspect system and tighten as needed.

MAINTENANCE AND USE:

1. The net and system are engineered to withstand heavy winds. Plastic cable ties are rated to break in excess winds to save the system. Occasional replacement of clips may be necessary. Please contact AAE to purchase proper load rated cable ties.
2. Occasional inspection is needed to keep system in proper tension. Turnbuckles may need to be re-tensioned if they come loose.
3. Please contact AAE with any questions.

FOR TECHNICAL ASSISTANCE, CALL 1-800-523-5471

K:\AAE Data\PDF Files\Z-Product Instructions & Parts Lists\BallStopper Systems\BBS-25-CD_12 Assembly Instructions.doc
Copyright © 2001 Aluminum Athletic Equipment Co.