

GP6R - Goal Post Pad - 6" I.D. Specifications

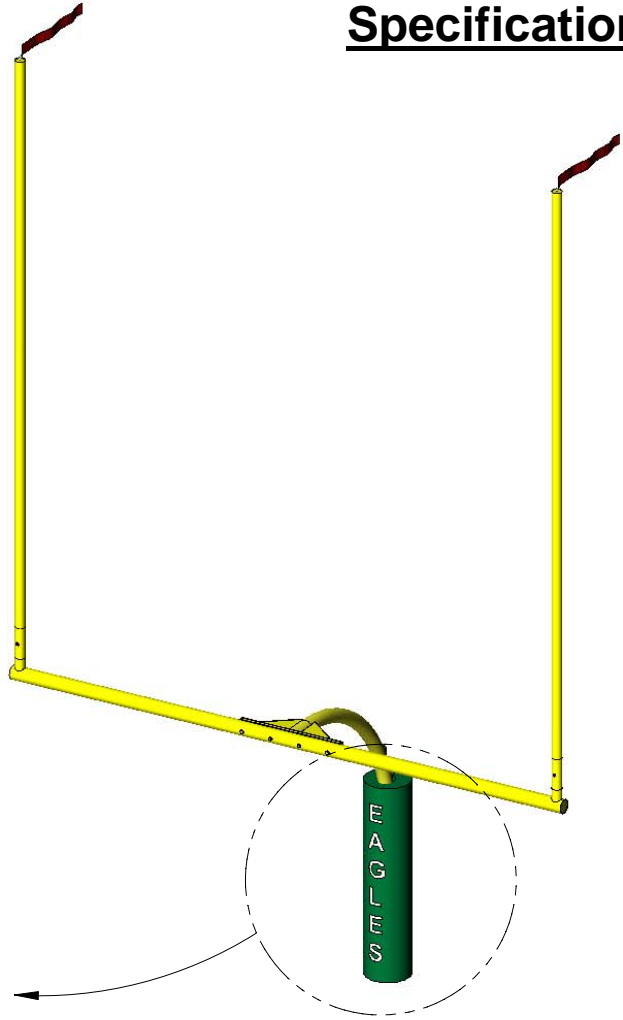
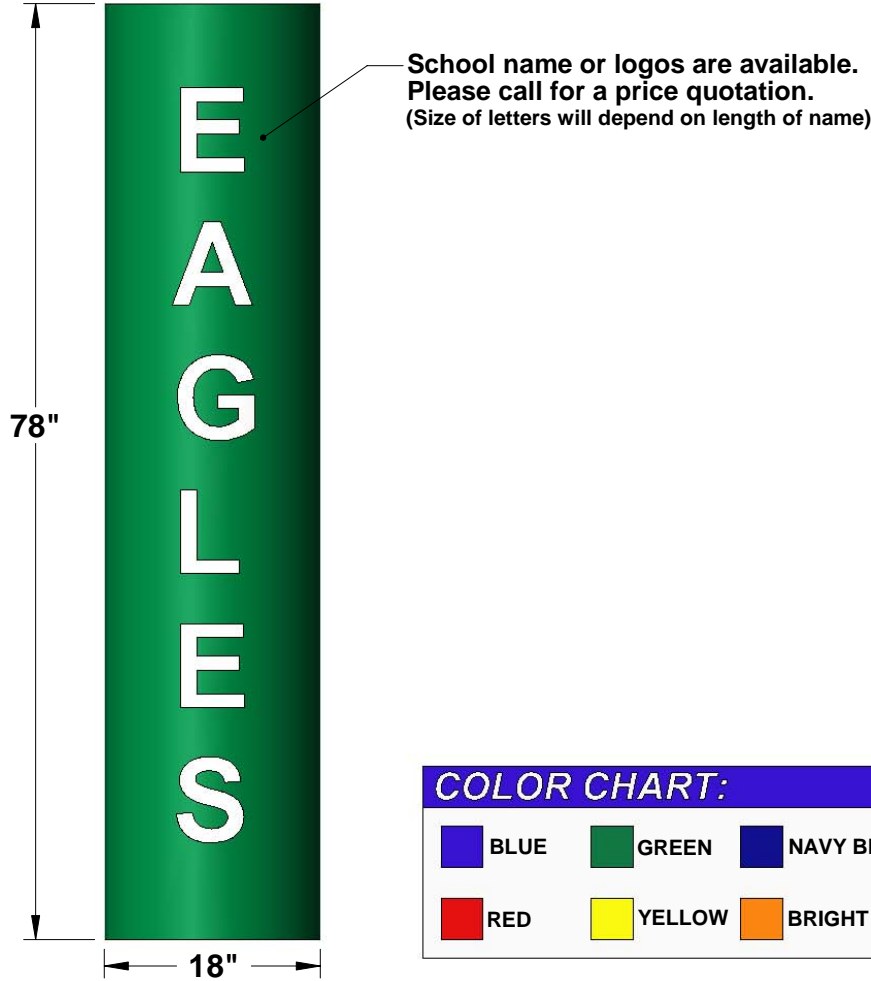
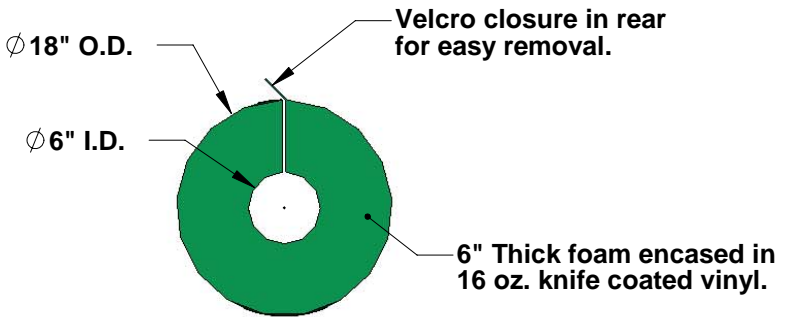

COLOR CHART:

BLUE	GREEN	NAVY BLUE	BLACK
RED	YELLOW	BRIGHT ORANGE	MAROON

AAE
 Aluminum Athletic Equipment
 1000 Enterprise Drive, Royersford, PA 19468
 Toll Free: (800) 523-5471 Phone: (610) 825-6565
 www.aaesports.com

DESCRIPTION:
GP6R - Goal Post Pad - 6" I.D. - Specifications

NOTE:
 Replaces Drawing No. AAE-208-F

MODEL: GP6R	CATEGORY: CUSTOMER	DATE: 12/8/04
DWN. BY: TAD	CAD FILE: GP6R- Specifications	DWG. NO. GP6R-C-001

GP6R - Goal Post Pad - 6" I.D. Specifications

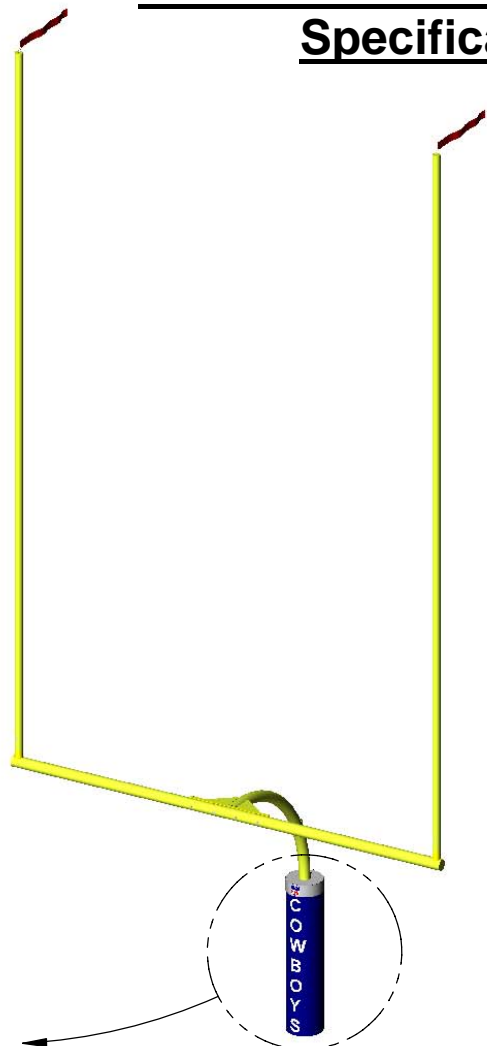
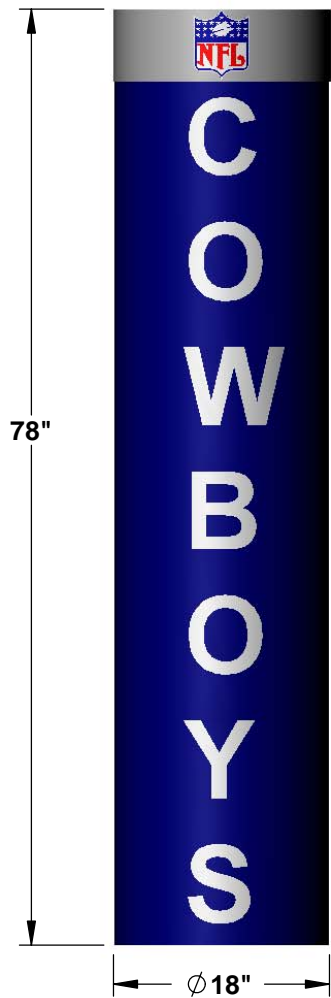
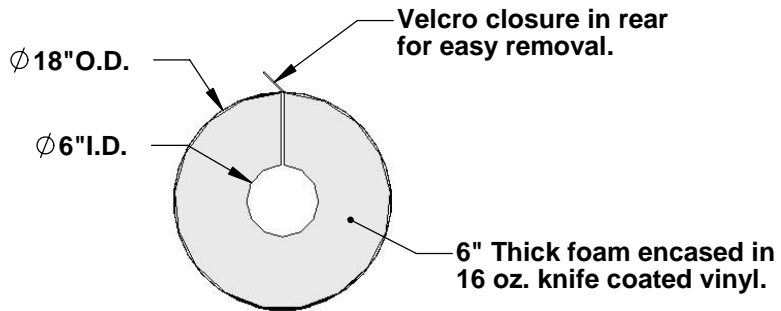

COLOR CHART:

	BLUE		GREEN		NAVY BLUE		BLACK
	RED		YELLOW		BRIGHT ORANGE		MAROON

AAE
 Aluminum Athletic Equipment
 1000 Enterprise Drive, Royersford, PA 19468
 Toll Free: (800) 523-5471 Phone: (610) 825-6565
 www.aaesports.com

DESCRIPTION:
GP6R - Goal Post Pad - 6" I.D. - Specifications







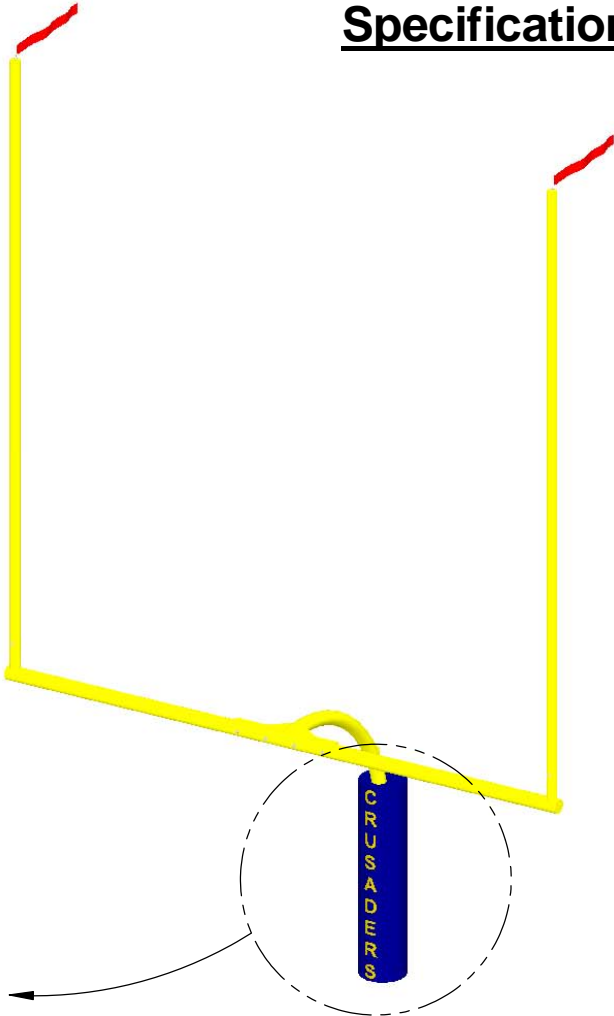
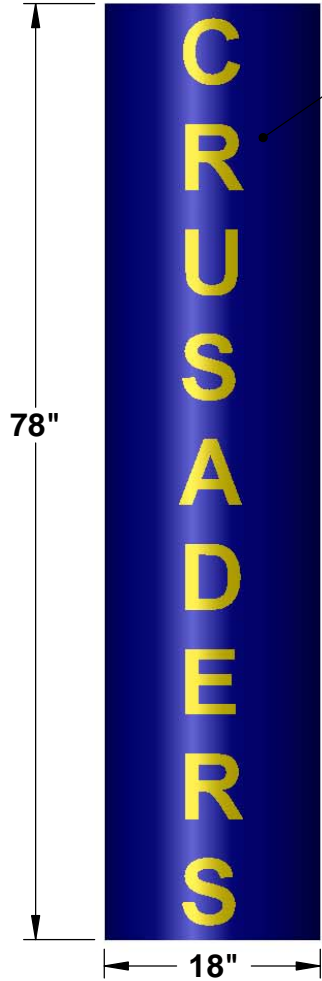
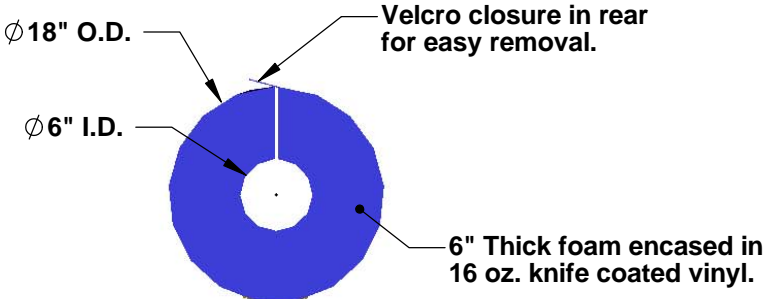

NOTE:
 Replaces Drawing No. AAE-208-F

MODEL: GP6R	CATEGORY: CUSTOMER	DATE: 12/8/04
DWN. BY: TAD	CAD FILE: GP6R- Specifications	DWG. NO. GP6R-C-001

GP6R - Goal Post Pad - 6" I.D. Specifications



COLOR CHART:

 BLUE	 GREEN	 NAVY BLUE	 BLACK
 RED	 YELLOW	 BRIGHT ORANGE	 MAROON

AAE
 Aluminum Athletic Equipment
 1000 Enterprise Drive, Royersford, PA 19468
 Toll Free: (800) 523-5471 Fax: (610) 825-2378
 www.aesports.com

DESCRIPTION: **GP6R - Goal Post Pad - 6" I.D. - Specifications**

NOTE: Custom Screened: CUBS

MODEL: GP6R	CATEGORY: CUSTOMER	DATE: 5/2/11
DWN. BY: TAD	CAD FILE: GP6R- Specifications	DWG. NO. GP6R-C-001

GP6R - Goal Post Pad - 6" I.D. Specifications

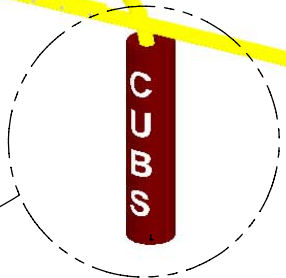
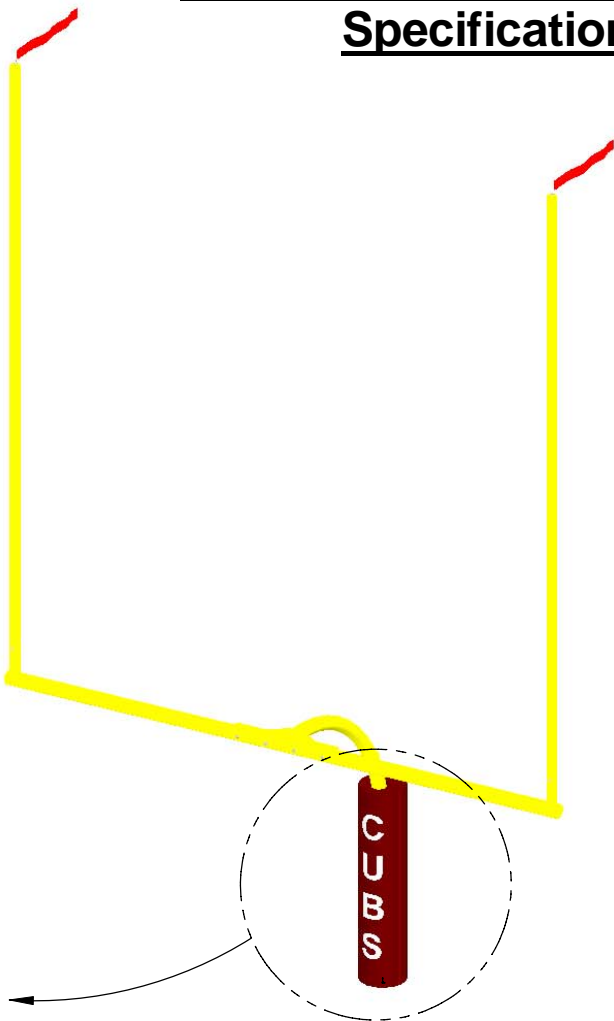
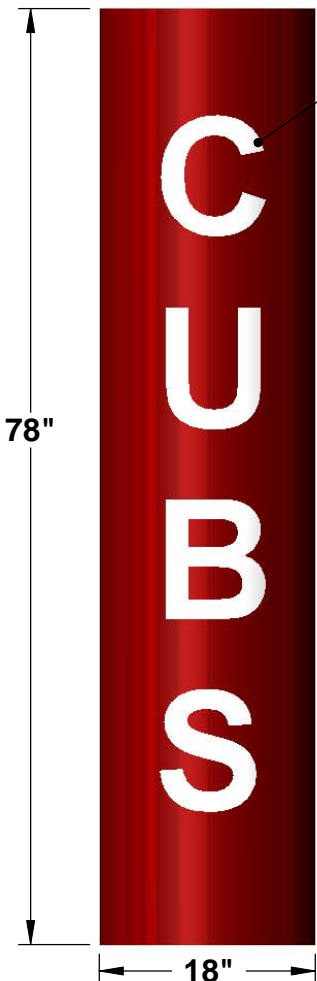
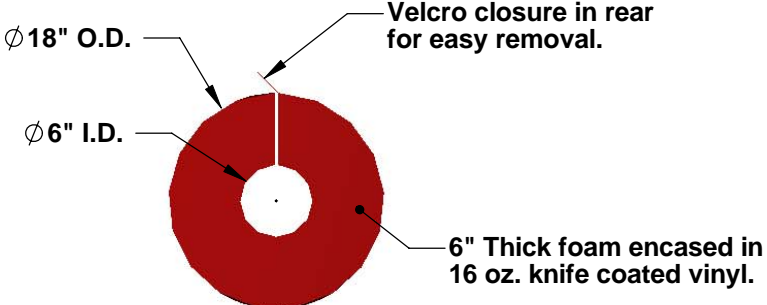

COLOR CHART:

BLUE	GREEN	NAVY BLUE	BLACK
RED	YELLOW	BRIGHT ORANGE	MAROON

AAE
 Aluminum Athletic Equipment
 1000 Enterprise Drive, Royersford, PA 19468
 Toll Free: (800) 523-5471 Fax: (610) 825-2378
 www.aaesports.com

DESCRIPTION: **GP6R - Goal Post Pad - 6" I.D. - Specifications**

NOTE: Custom Screened: CUBS

MODEL: GP6R	CATEGORY: CUSTOMER	DATE: 5/2/11
DWN. BY: TAD	CAD FILE: GP6R- Specifications	DWG. NO. GP6R-C-001

GP6R - Goal Post Pad - 6" I.D. Specifications

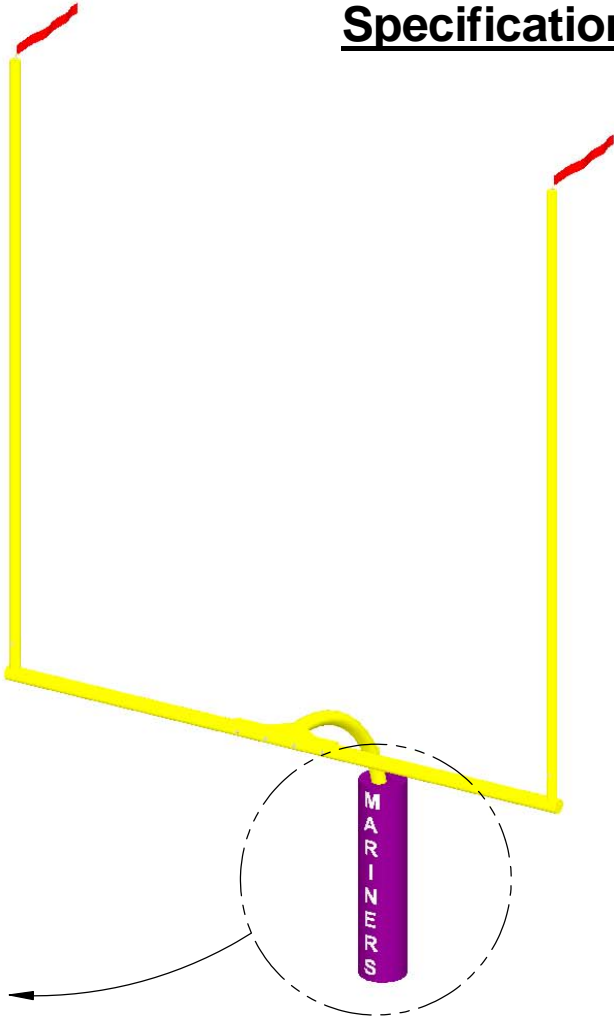
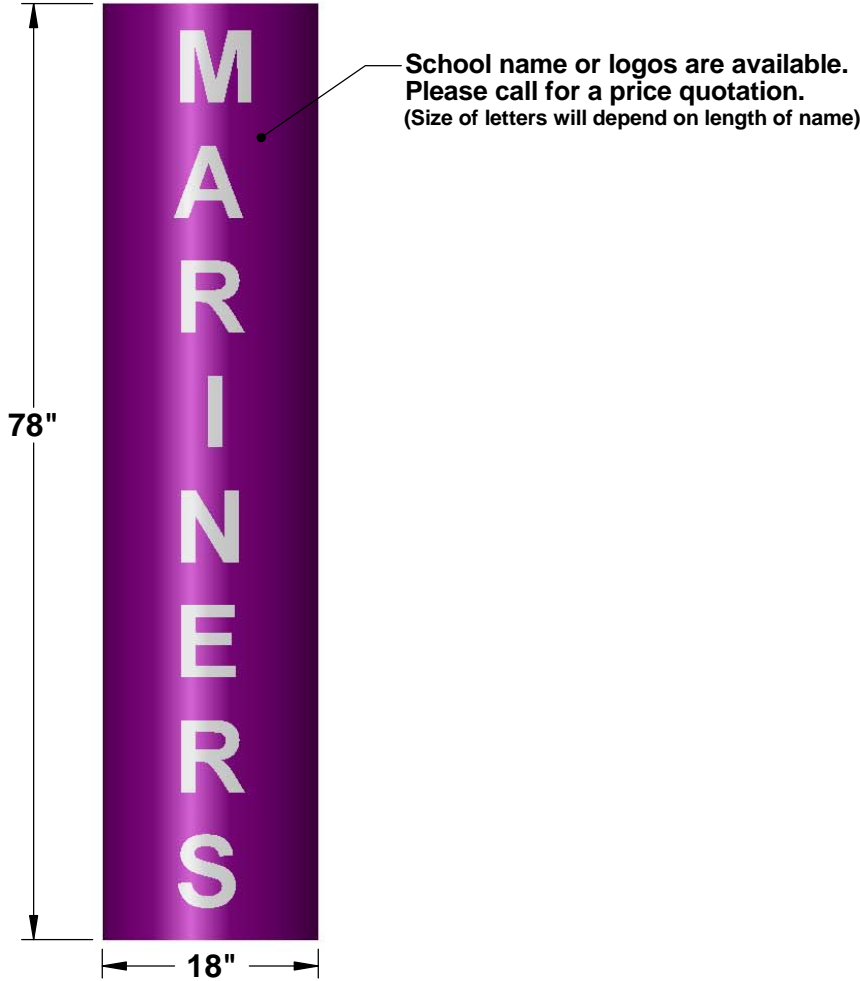
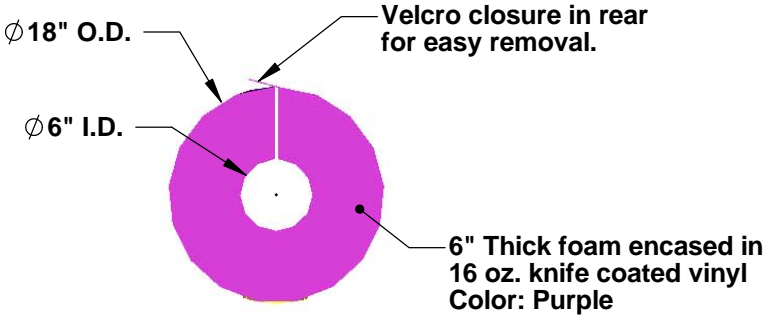

AAE
 Aluminum Athletic Equipment
 1000 Enterprise Drive, Royersford, PA 19468
 Toll Free: (800) 523-5471 Fax: (610) 825-2378
www.aesports.com

DESCRIPTION:		
GP6R - Goal Post Pad - 6" I.D. - Specifications		
NOTE: Custom Screened: MARINERS in White on Purple Vinyl		
MODEL:	CATEGORY:	DATE:
GP6R	CUSTOMER	8/7/14
DWN. BY:	CAD FILE:	DWG. NO.
TAD	GP6R- Specifications	GP6R-C-001