

MBS-35/IF
35' High Multi-Sport BallStopper System w/ Integrated Fence
Specification

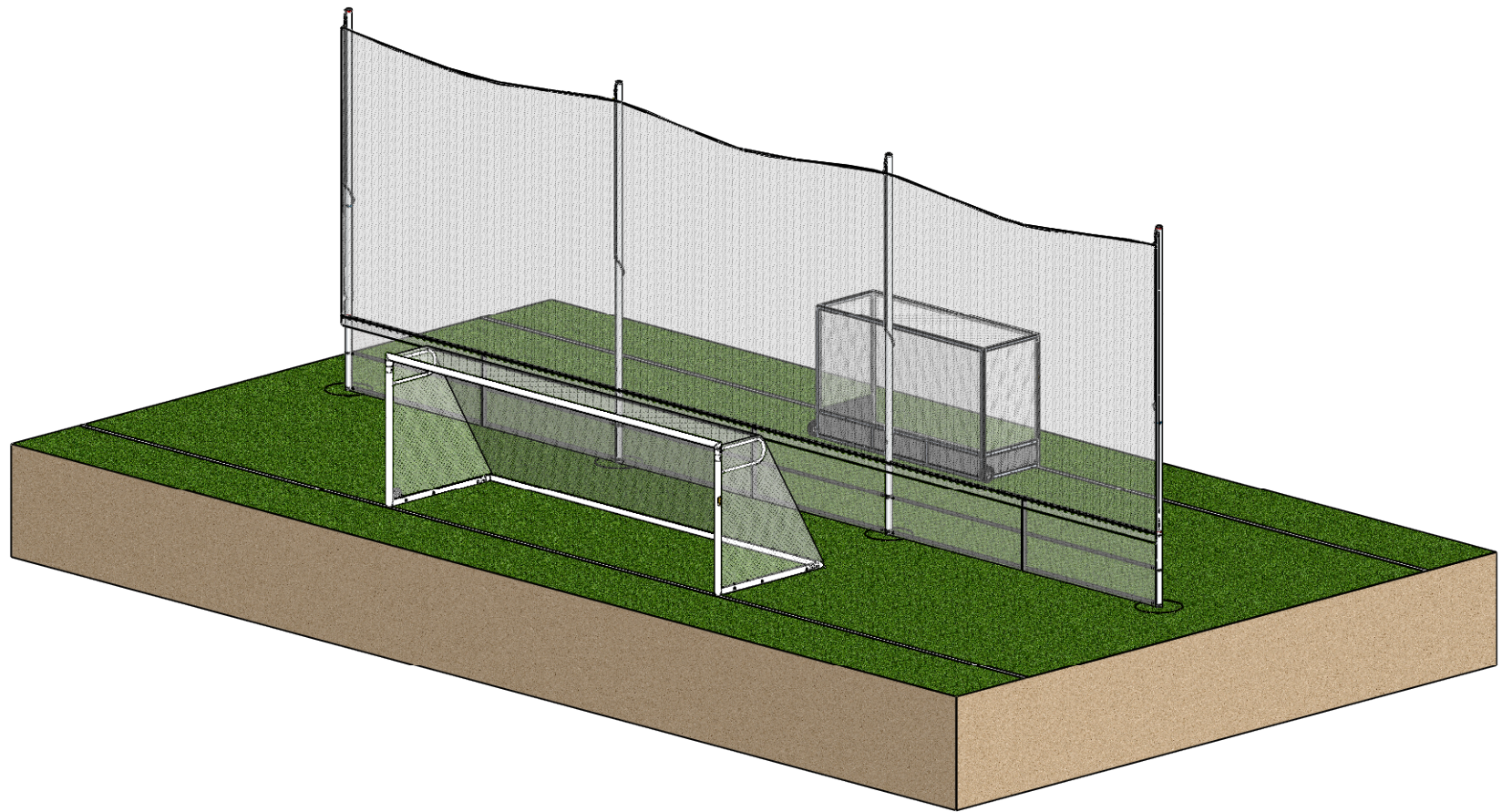

Aluminum Athletic Equipment
1000 Enterprise Drive, Royersford, PA 19468
Toll Free: (800) 523-5471 Fax: (610) 825-2378
www.AAEsports.com

MBS-35-IF - 35' BallStopper - Integrated Fence Specifications

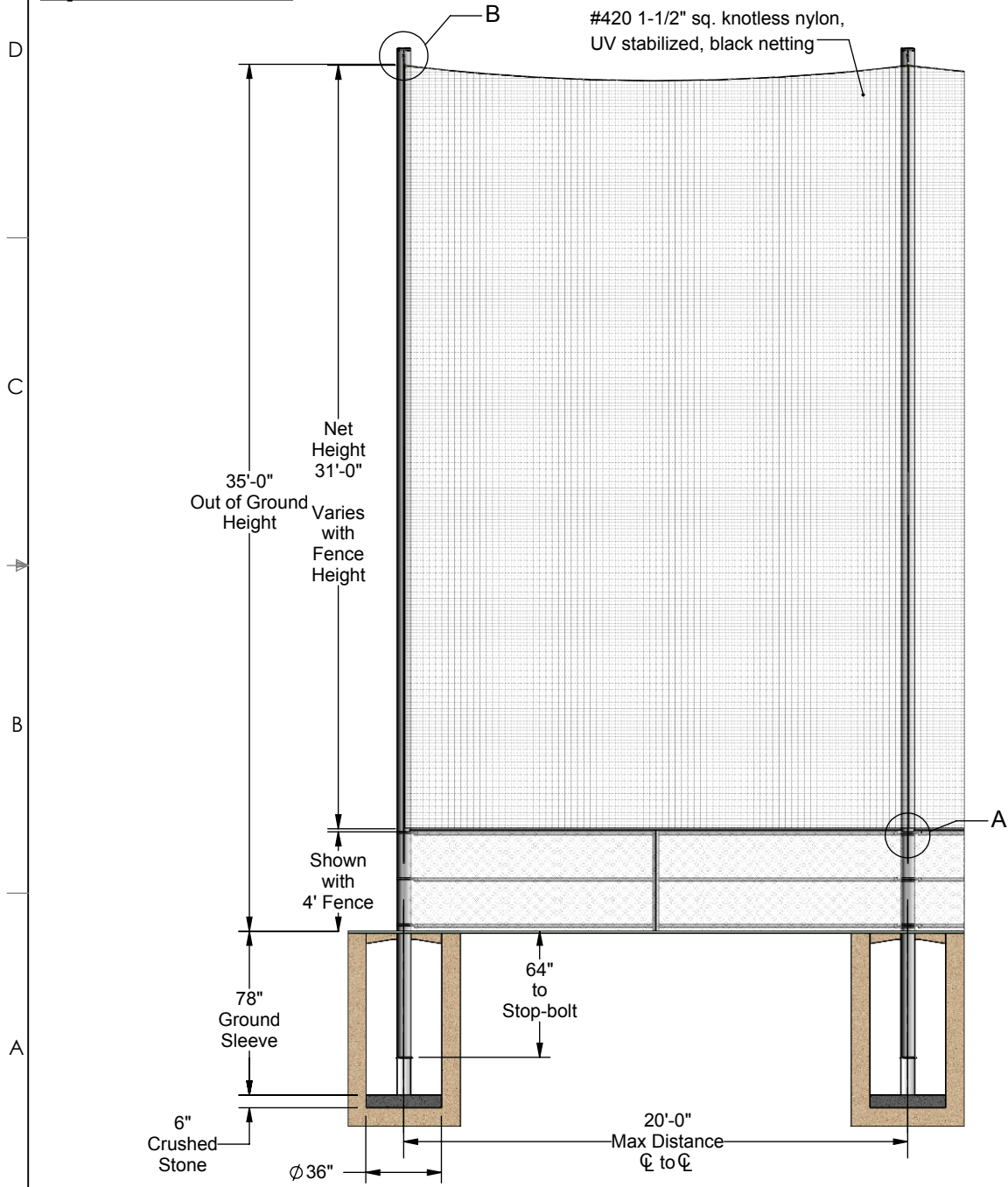

6.625" dia. x .280" wall
Aluminum Pole

Pulley system allows for net to be raised and lowered with ease

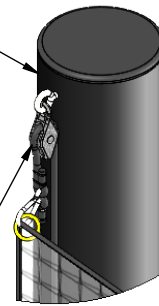

DETAIL B

Rail Ends (Supplied by Other)

6.625" Brace Bands (Supplied by Other)

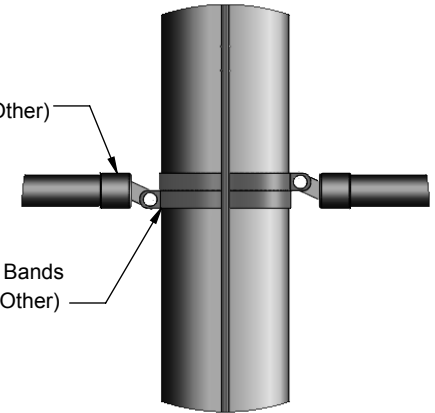

DETAIL A



Aluminum Athletic Equipment
1000 Enterprise Drive, Royersford, PA 19468
Toll Free: (800) 523-5471 Fax: (610) 825-2378
www.AAEsports.com

DESCRIPTION:

MBS-35-IF - Specifications

NOTE:

35' BallStopper with Inegrated Fence

MODEL:

MBS-35-IF

CATEGORY:

CUSTOMER

DATE:

2/26/2018

DWN. BY:

CED

CAD FILE:

MBS-35-IF Specifications

DWG. NO.

MBS-35-IF-C-001

MBS-XX-IF

Upright Specifications

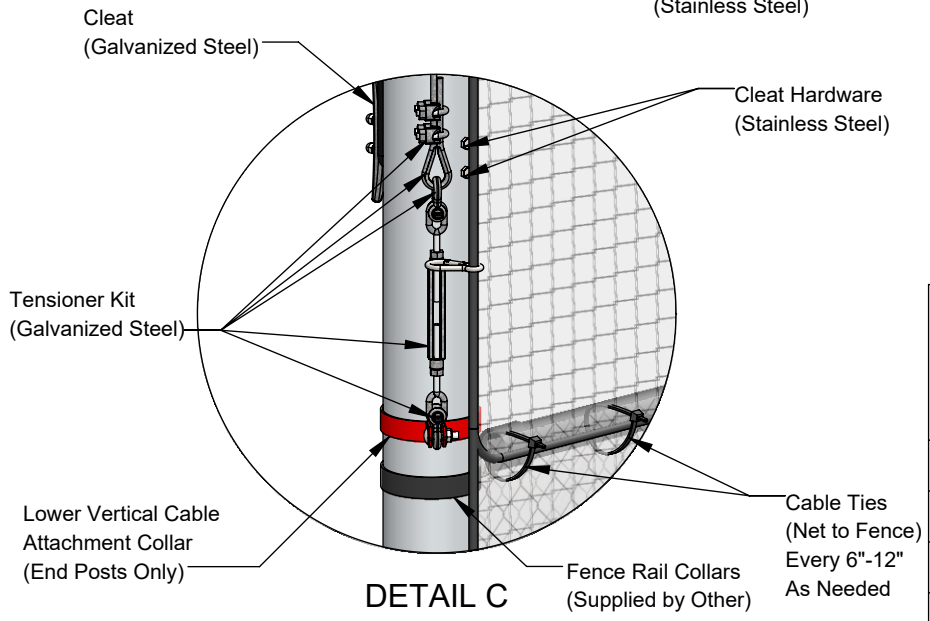
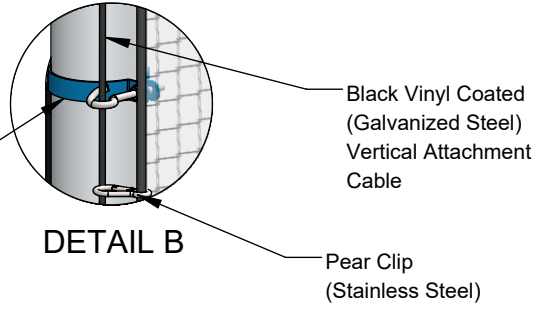
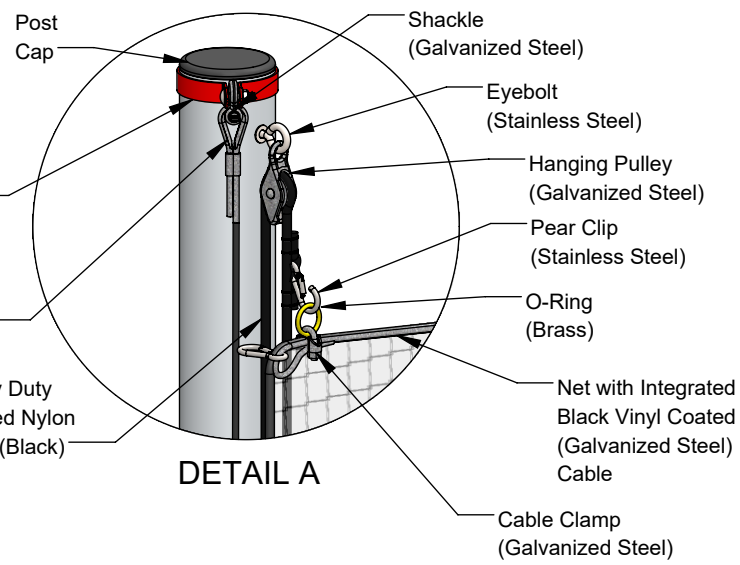
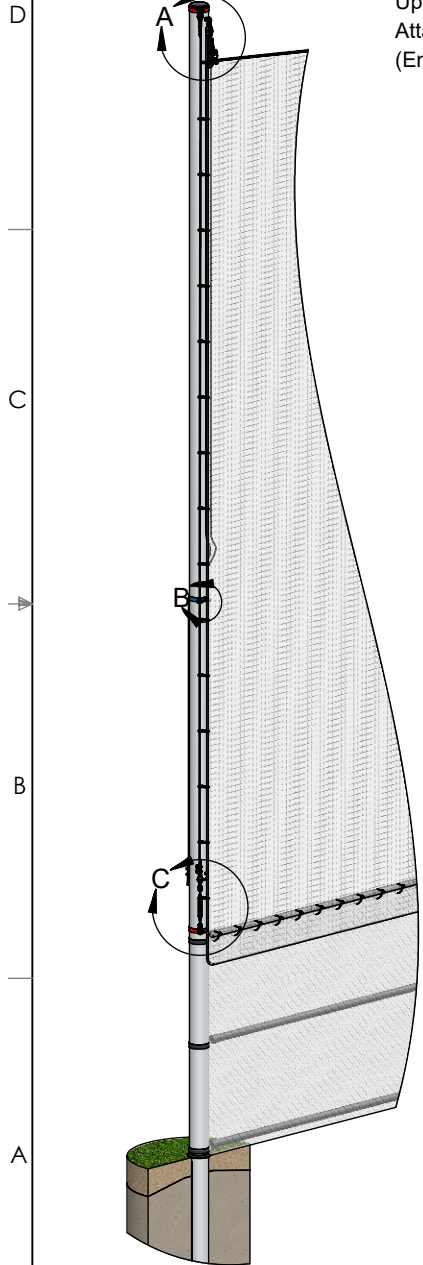



Aluminum Athletic Equipment
 1000 Enterprise Drive, Royersford, PA 19468
 Toll Free: (800) 523-5471 Fax: (610) 825-2378
www.AAEsports.com

DESCRIPTION:		
MBS-XX-IF Upright Specifications		
NOTE: Upright Assembly Specification		
MODEL:	CATEGORY:	DATE:
MBS-IF	CUSTOMER	6/1/2023
DWN. BY:	CAD FILE:	DWG. NO.:
CED	MBS-XX-IF Specifications	MBS-IF-C-001

MBS-XX-IF

Assembly Instruction

Net Attachment

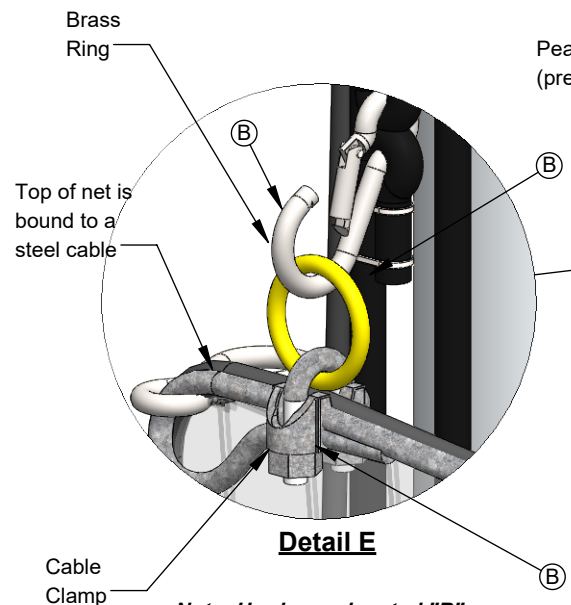
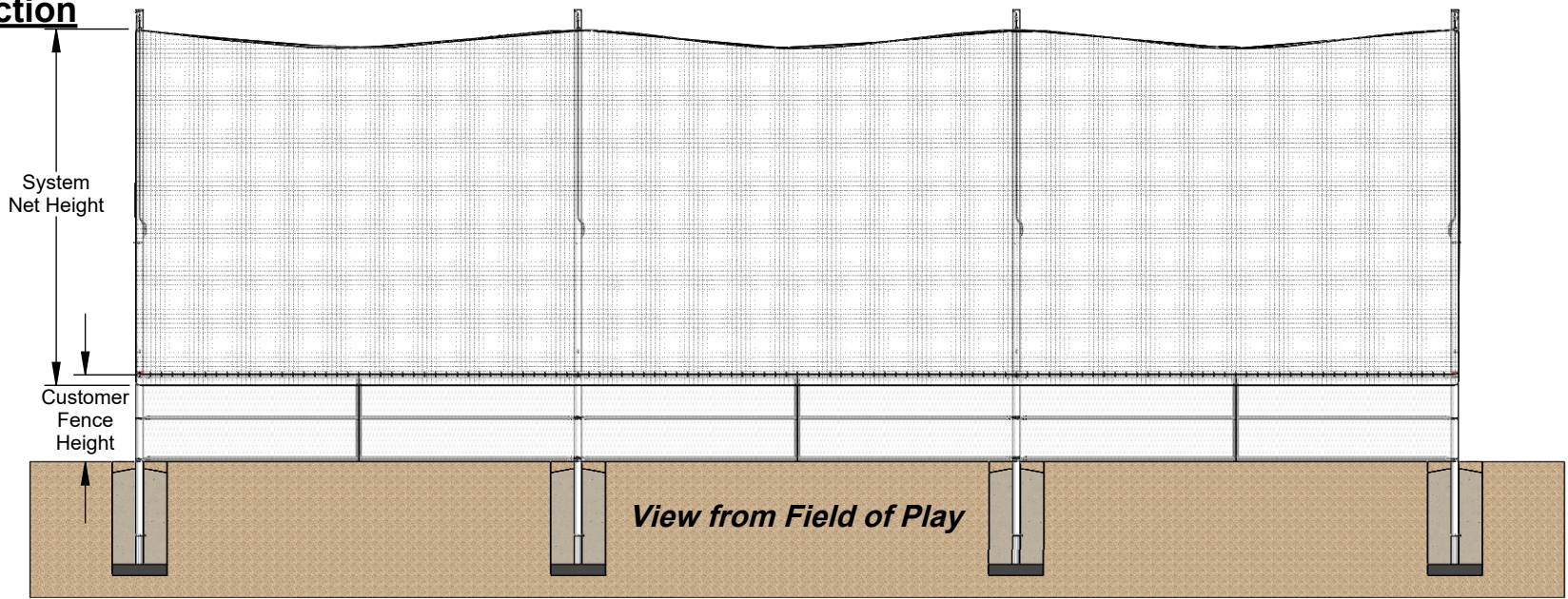

Note: Hardware denoted "B" is included in the item "Hoist Rope"

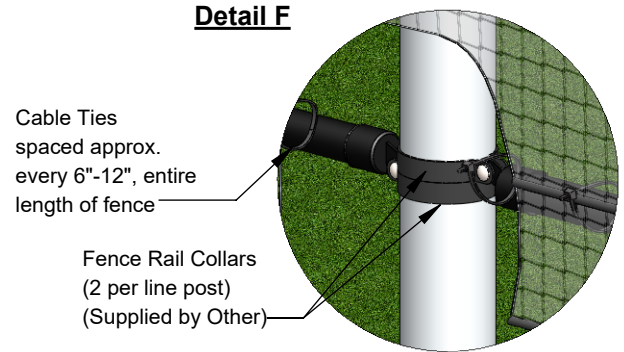
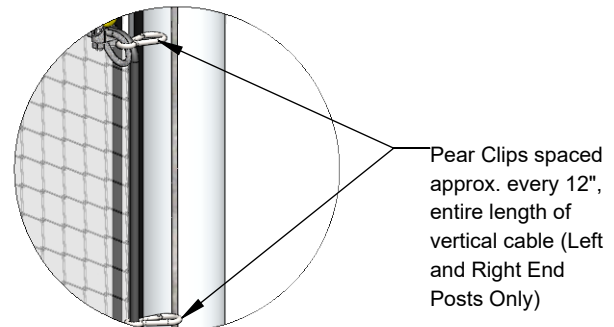
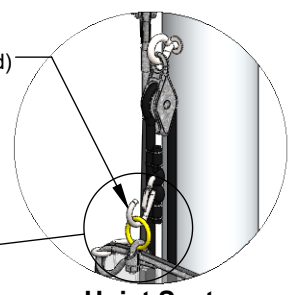



Aluminum Athletic Equipment
 1000 Enterprise Drive, Royersford, PA 19468
 Toll Free: (800) 523-5471 Fax: (610) 825-2378
 www.AAEsports.com

DESCRIPTION:		
MBS-XX-IF - Net Attachment		
NOTE: Specifications		
MODEL:	CATEGORY:	DATE:
MBS-IF	CUSTOMER	04/05/2021
DWN. BY:	CAD FILE:	DWG. NO.:
CED	MBS-XX-IF - Specifications	MBS-IF-C-002

MBS-XX-IF
Multi-Section System
Net Preparation

D

C

B

A

Cable Ties
 40 lbs.
 Strength

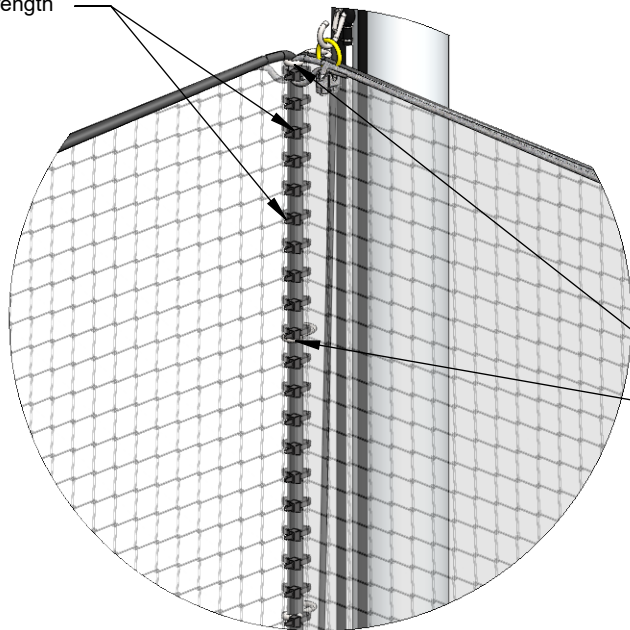

DETAIL I

Pear Clips
 Spaced approx.
 every 12", entire
 length of vertical
 cable (Left, Right
 & Shared End Posts)

Net Vertical
 1/4" MFP
 Double Braided
 Rope Border

Net "A"

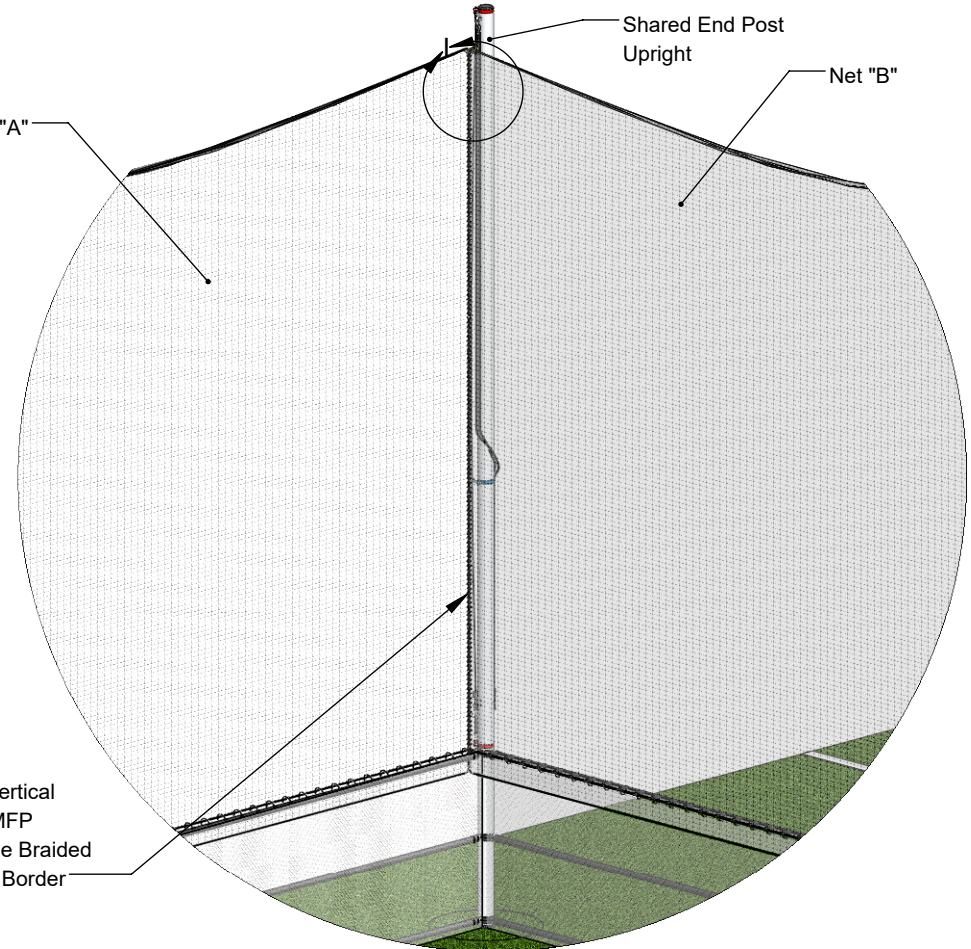

Shared End Post
 Upright

Net "B"

Multi-Section System
Corner Attachment



Aluminum Athletic Equipment
 1000 Enterprise Drive, Royersford, PA 19468
 Toll Free: (800) 523-5471 Fax: (610) 825-2378
 www.AAEsports.com

DESCRIPTION:		
Multi-Section Net Assembly		
NOTE: Specifications		
MODEL:	CATEGORY:	DATE:
MBS-IF	CUSTOMER	04/06/2021
DWN. BY:	CAD FILE:	DWG. NO.:
CED	MBS-XX-IF - Specifications	MBS-IF-C-003

6

5

4

3

2

1

MBS-IF - BallStopper - Integrated Fence

Pre-Fabrication Form

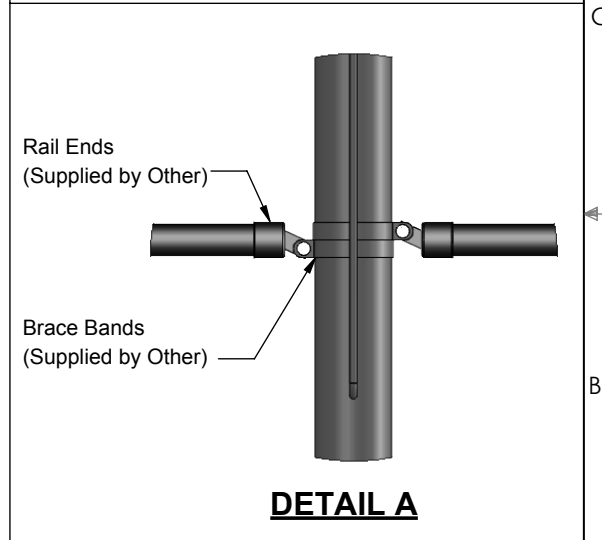
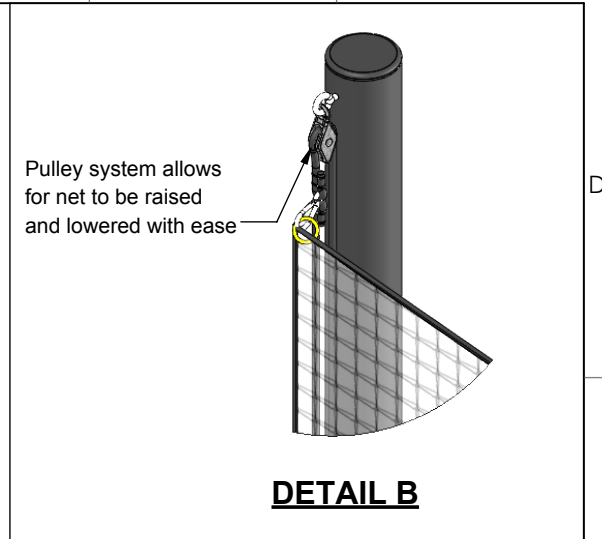
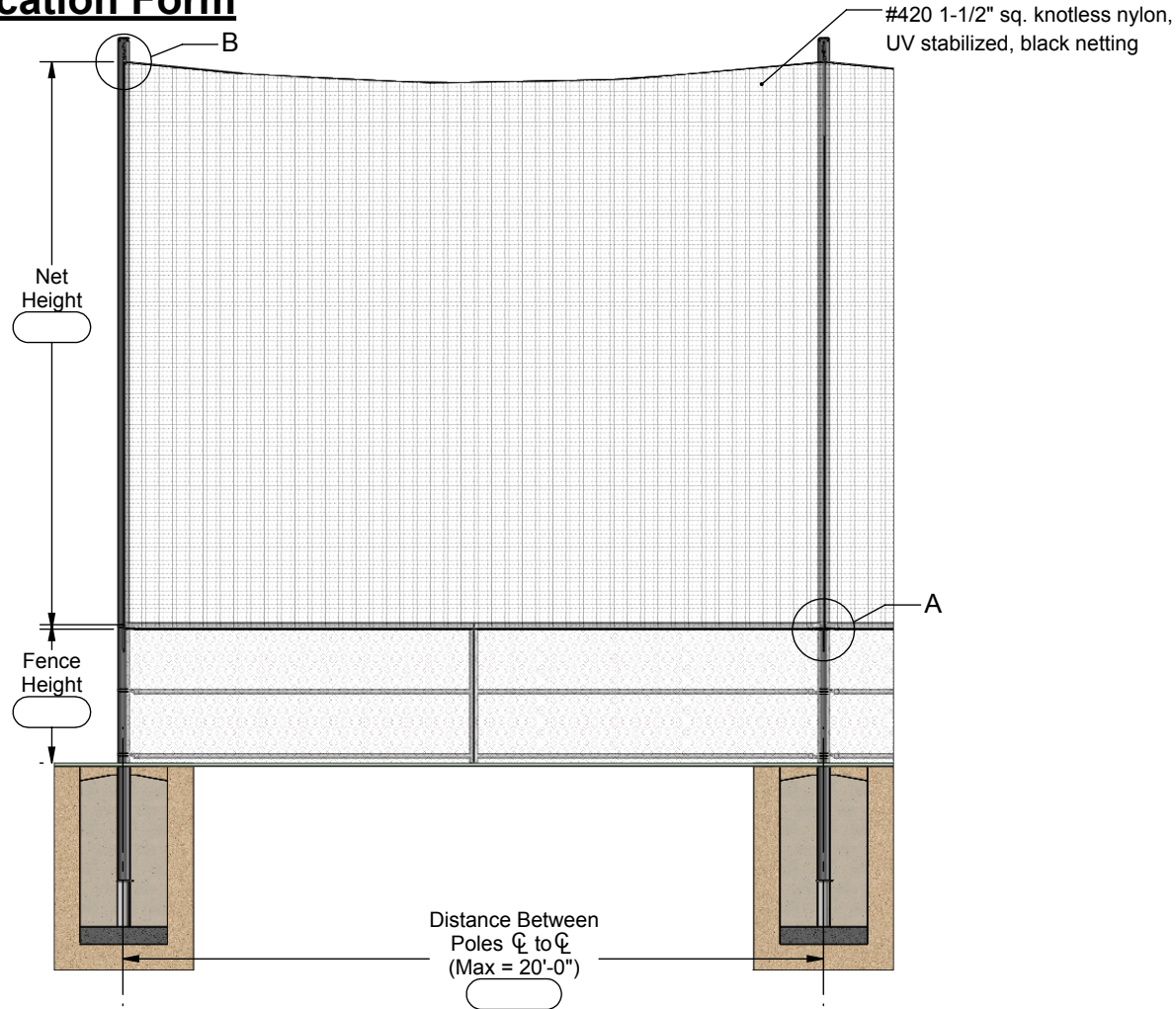

Project Name:	
Quote No.:	
Net Height:	
Fence Height:	
Distance Between Poles:	
Customer Signature:	
Customer Notes:	



Aluminum Athletic Equipment
 1000 Enterprise Drive, Royersford, PA 19468
 Toll Free: (800) 523-5471 Fax: (610) 825-2378
www.AAEsports.com

DESCRIPTION: MBS-IF - Pre-Fabrication Form		
NOTE: BallStopper with Inegrated Fence		
MODEL: MBS-IF	CATEGORY: CUSTOMER	DATE: 2/27/2018
DWN. BY: CED	CAD FILE: MBS-IF Pre-fab	DWG. NO. MBS-IF-C-001