

MBS-40/IF
40' High Multi-Sport BallStopper System w/ Integrated Fence
Specification

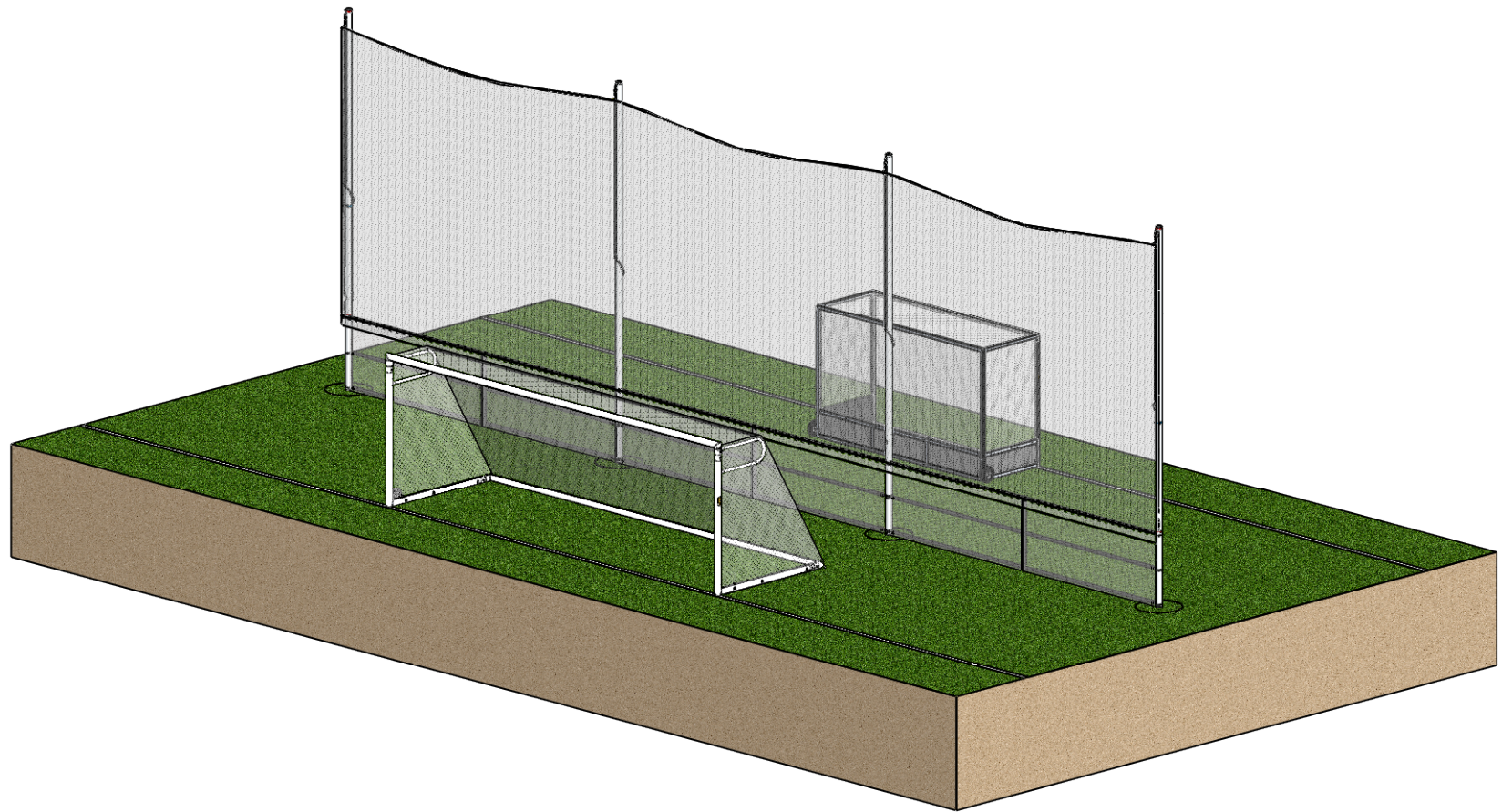

Aluminum Athletic Equipment
1000 Enterprise Drive, Royersford, PA 19468
Toll Free: (800) 523-5471 Fax: (610) 825-2378
www.AAEsports.com

MBS-40-IF - 40' BallStopper - Integrated Fence

Specifications

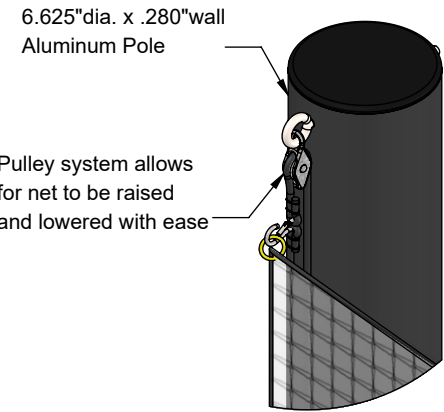
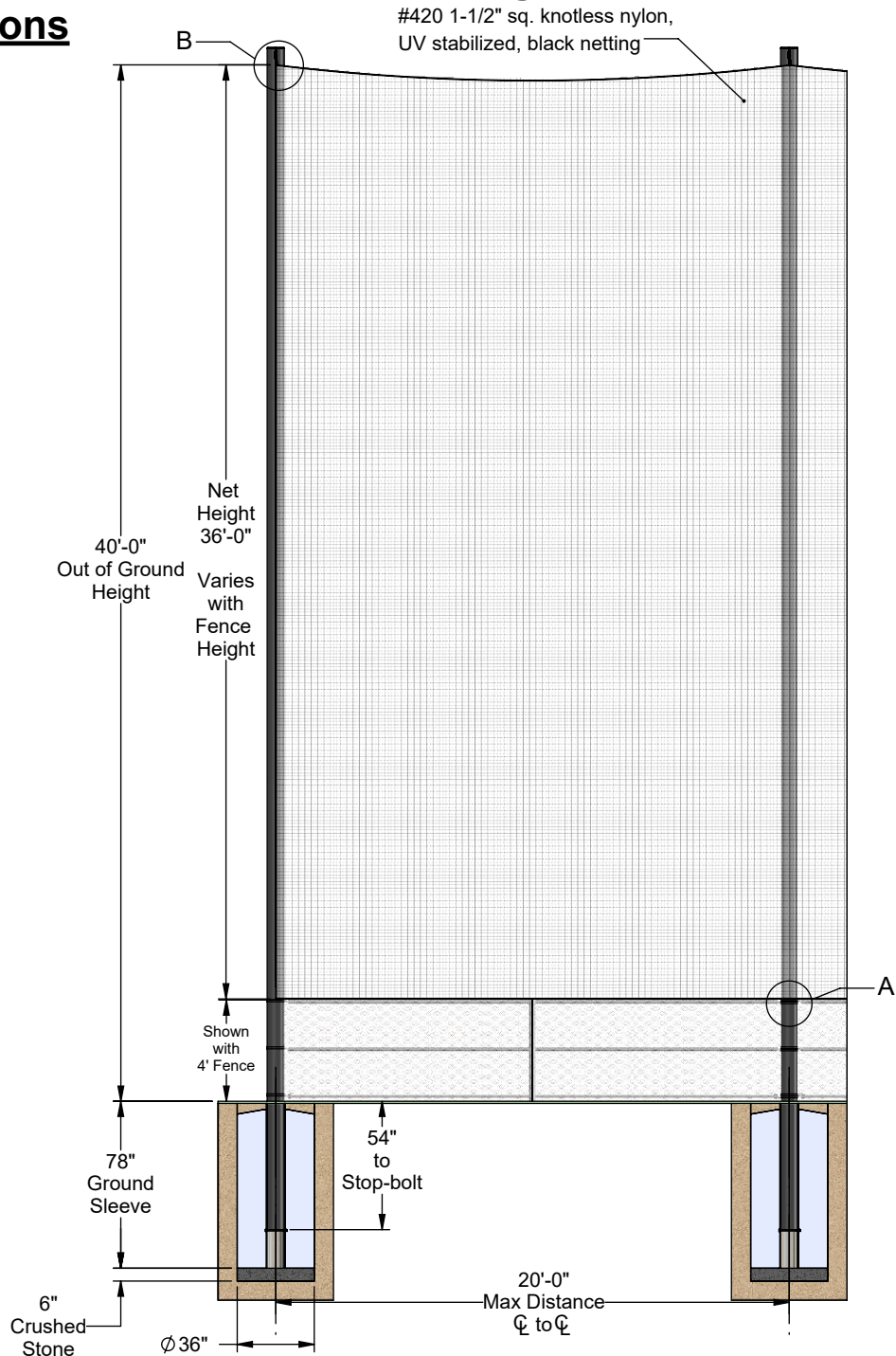

DETAIL B

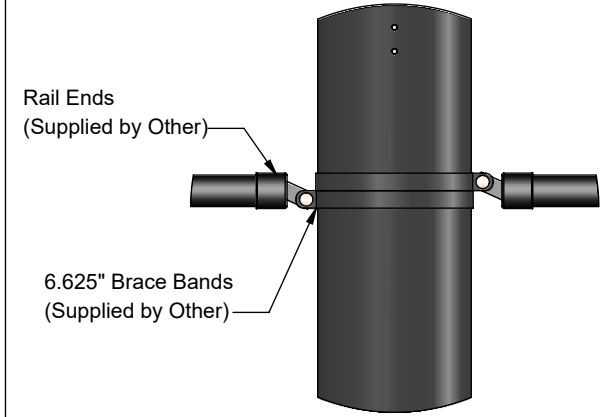

DETAIL A





Aluminum Athletic Equipment
 1000 Enterprise Drive, Royersford, PA 19468
 Toll Free: (800) 523-5471 Fax: (610) 825-2378
 www.AAEsports.com

DESCRIPTION:		
MBS-40-IF - Specifications		
NOTE:		
40' BallStopper with Inegrated Fence		
MODEL:	CATEGORY:	DATE:
MBS-40-IF	CUSTOMER	3/18/2022
DWN. BY:	CAD FILE:	DWG. NO.:
CED	MBS-40-IF Specifications	MBS-40-IF-C-001

MBS-XX-IF

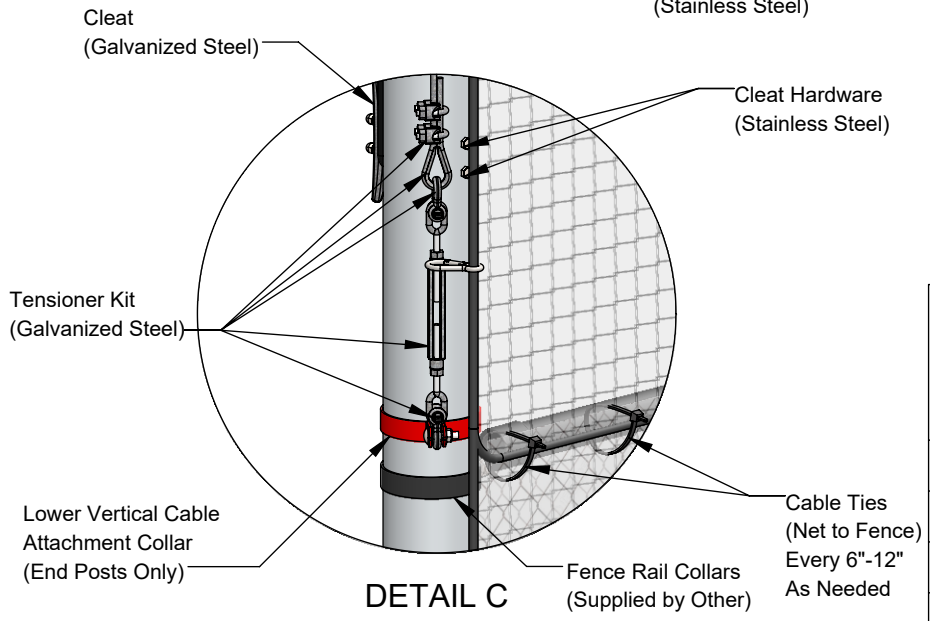
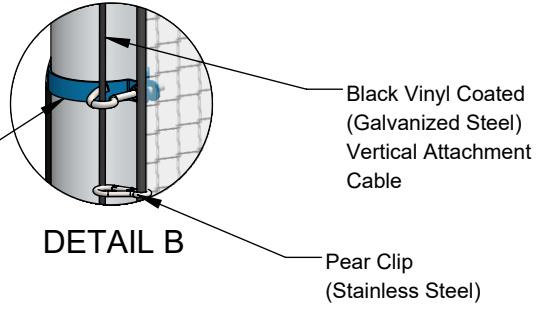
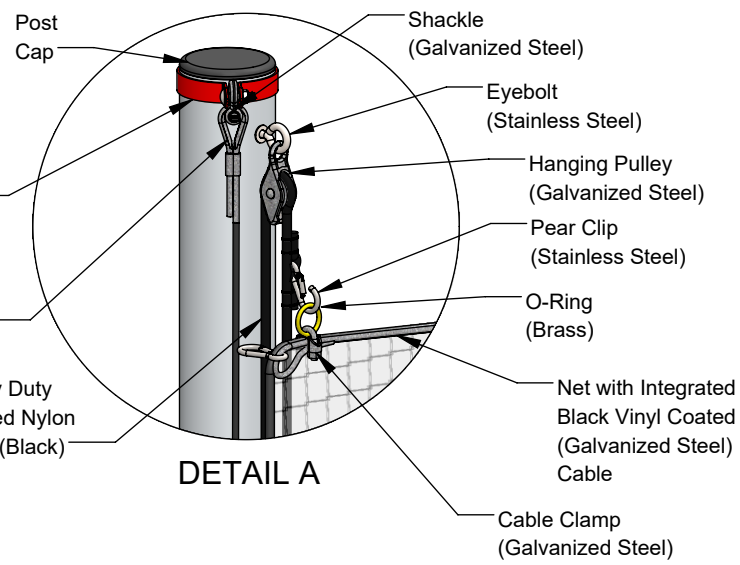
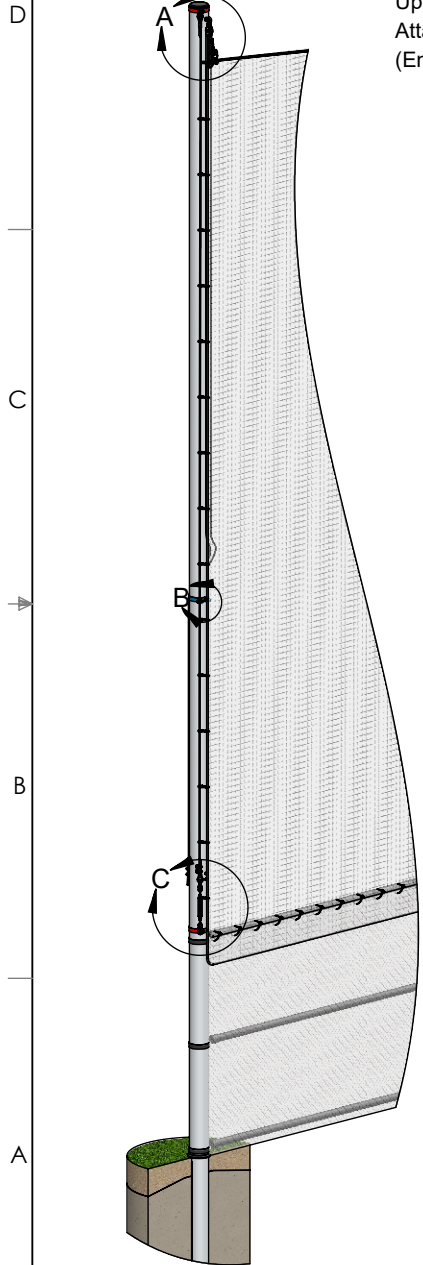
Upright Specifications





Aluminum Athletic Equipment
 1000 Enterprise Drive, Royersford, PA 19468
 Toll Free: (800) 523-5471 Fax: (610) 825-2378
www.AAEsports.com

DESCRIPTION:		
MBS-XX-IF Upright Specifications		
NOTE: Upright Assembly Specification		
MODEL:	CATEGORY:	DATE:
MBS-IF	CUSTOMER	6/1/2023
DWN. BY:	CAD FILE:	DWG. NO.:
CED	MBS-XX-IF Specifications	MBS-IF-C-001

MBS-XX-IF

Assembly Instruction

Net Attachment

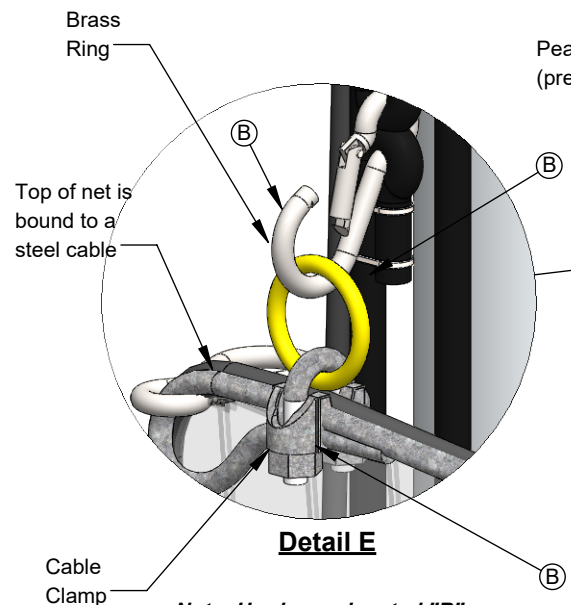
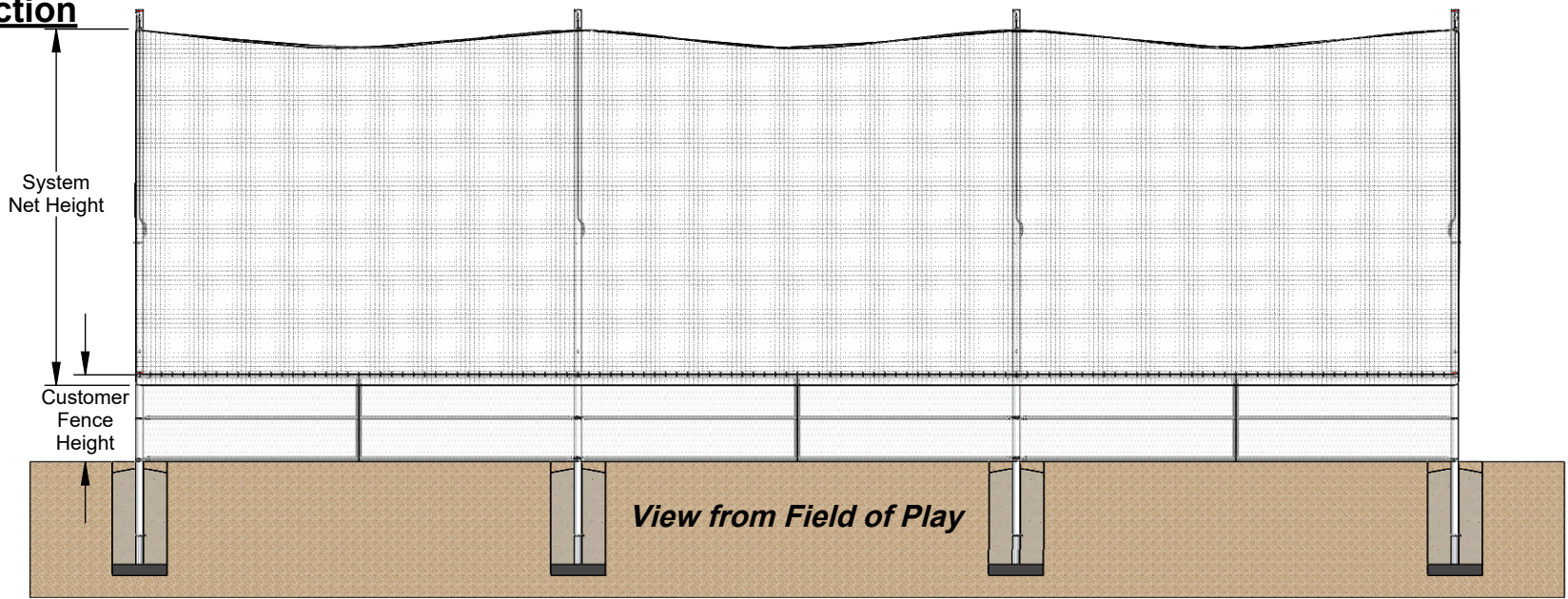

Note: Hardware denoted "B" is included in the item "Hoist Rope"

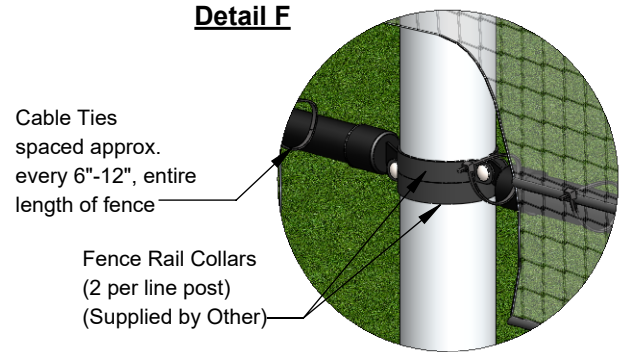
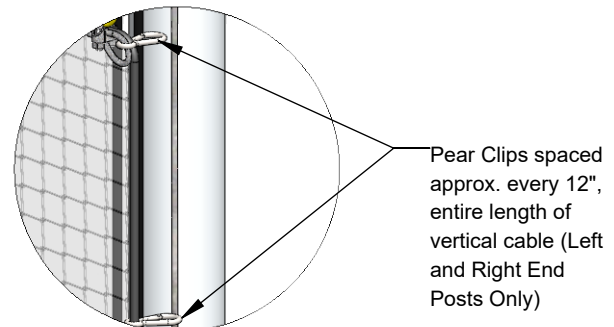
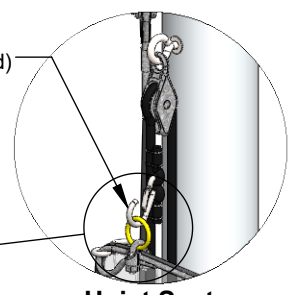

 Aluminum Athletic Equipment 1000 Enterprise Drive, Royersford, PA 19468 Toll Free: (800) 523-5471 Fax: (610) 825-2378 www.AAEsports.com		
DESCRIPTION: MBS-XX-IF - Net Attachment		
NOTE: Specifications		
MODEL: MBS-IF	CATEGORY: CUSTOMER	DATE: 04/05/2021
DWN. BY: CED	CAD FILE: MBS-XX-IF - Specifications	DWG. NO. MBS-IF-C-002

MBS-XX-IF
Multi-Section System
Net Preparation

D

C

B

A

Cable Ties
 40 lbs.
 Strength

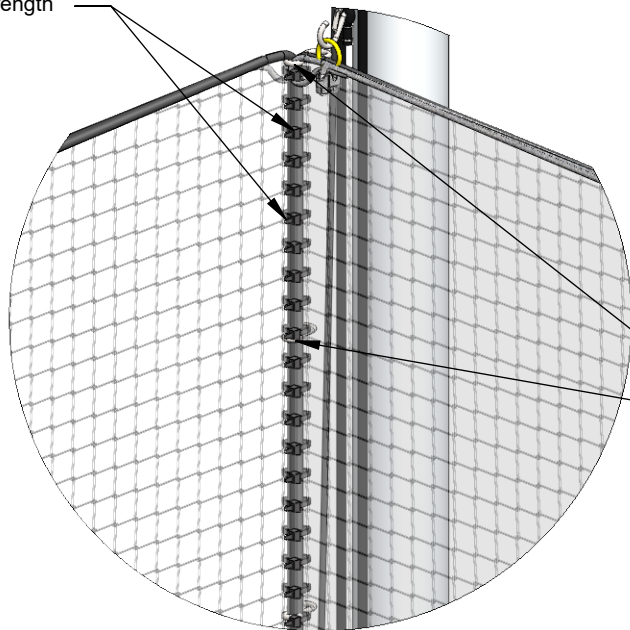

DETAIL I

Net "A"

Net Vertical
 1/4" MFP
 Double Braided
 Rope Border

Pear Clips
 Spaced approx.
 every 12", entire
 length of vertical
 cable (Left, Right
 & Shared End Posts)

Shared End Post
 Upright

Net "B"

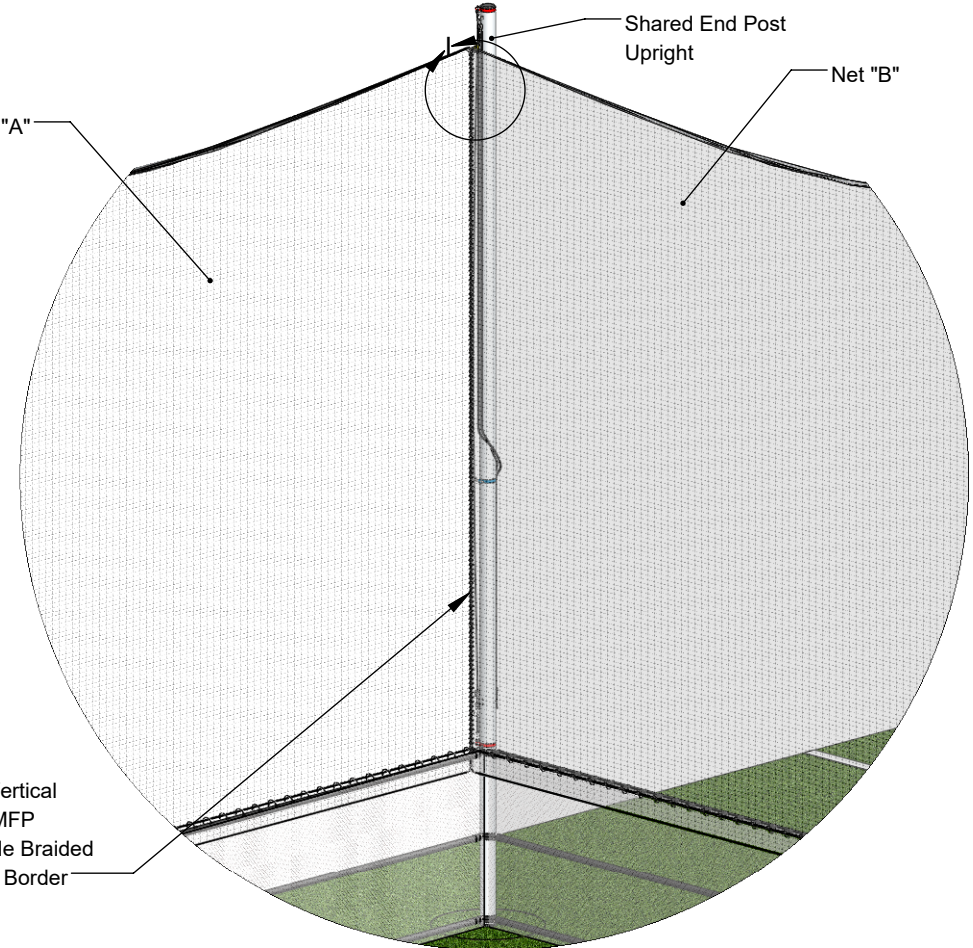

D

C

B

A

Multi-Section System
Corner Attachment



Aluminum Athletic Equipment
 1000 Enterprise Drive, Royersford, PA 19468
 Toll Free: (800) 523-5471 Fax: (610) 825-2378
 www.AAEsports.com

DESCRIPTION:		
Multi-Section Net Assembly		
NOTE: Specifications		
MODEL:	CATEGORY:	DATE:
MBS-IF	CUSTOMER	04/06/2021
DWN. BY:	CAD FILE:	DWG. NO.:
CED	MBS-XX-IF - Specifications	MBS-IF-C-003

6

5

4

3

2

1

MBS-IF - BallStopper - Integrated Fence

Pre-Fabrication Form

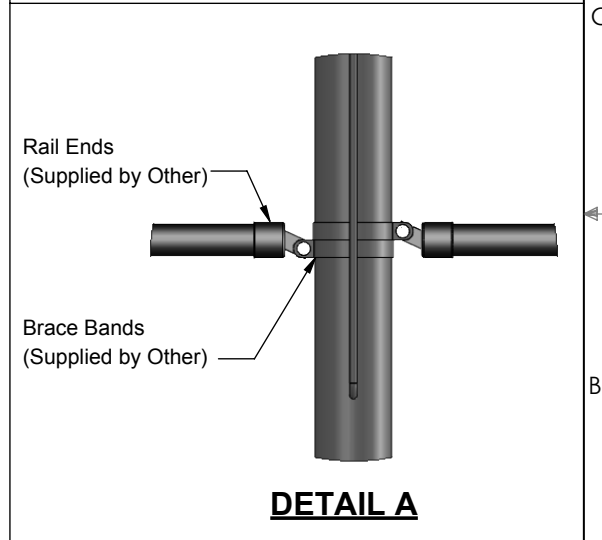
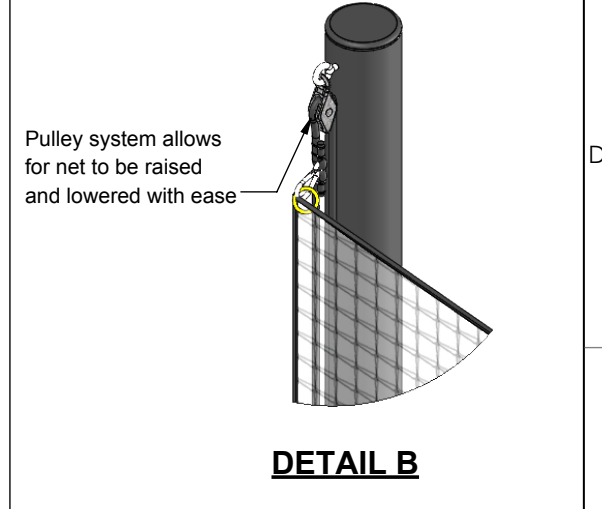
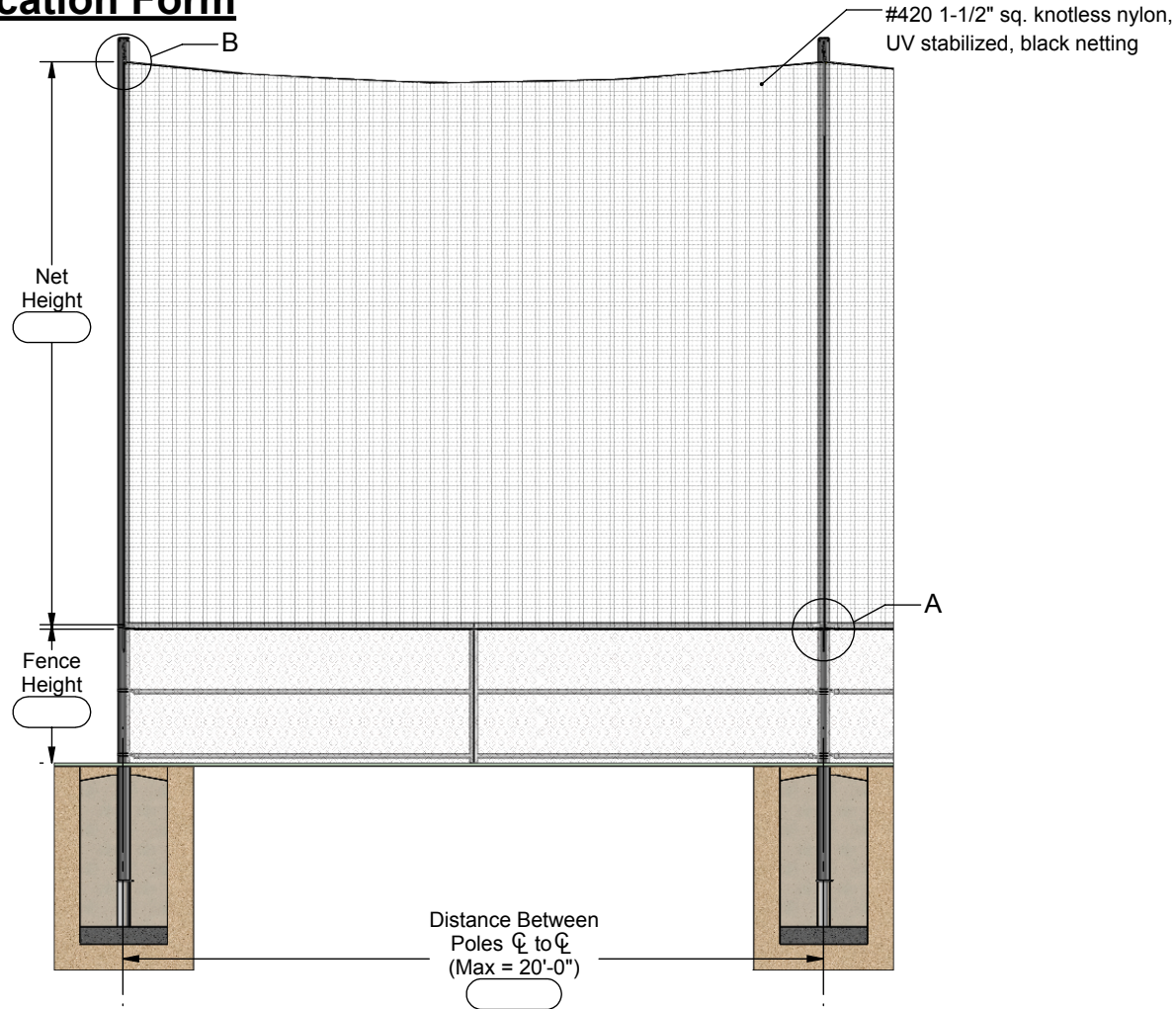

Project Name:	
Quote No.:	
Net Height:	
Fence Height:	
Distance Between Poles:	
Customer Signature:	
Customer Notes:	



Aluminum Athletic Equipment
 1000 Enterprise Drive, Royersford, PA 19468
 Toll Free: (800) 523-5471 Fax: (610) 825-2378
www.AAEsports.com

DESCRIPTION: MBS-IF - Pre-Fabrication Form		
NOTE: BallStopper with Inegrated Fence		
MODEL: MBS-IF	CATEGORY: CUSTOMER	DATE: 2/27/2018
DWN. BY: CED	CAD FILE: MBS-IF Pre-fab	DWG. NO. MBS-IF-C-001