

**AAE Model No. PFS-NCAA-SC**  
**NCAA Long Jump/Triple Jump**  
**Pit Form System**  
**with Sand Catcher**

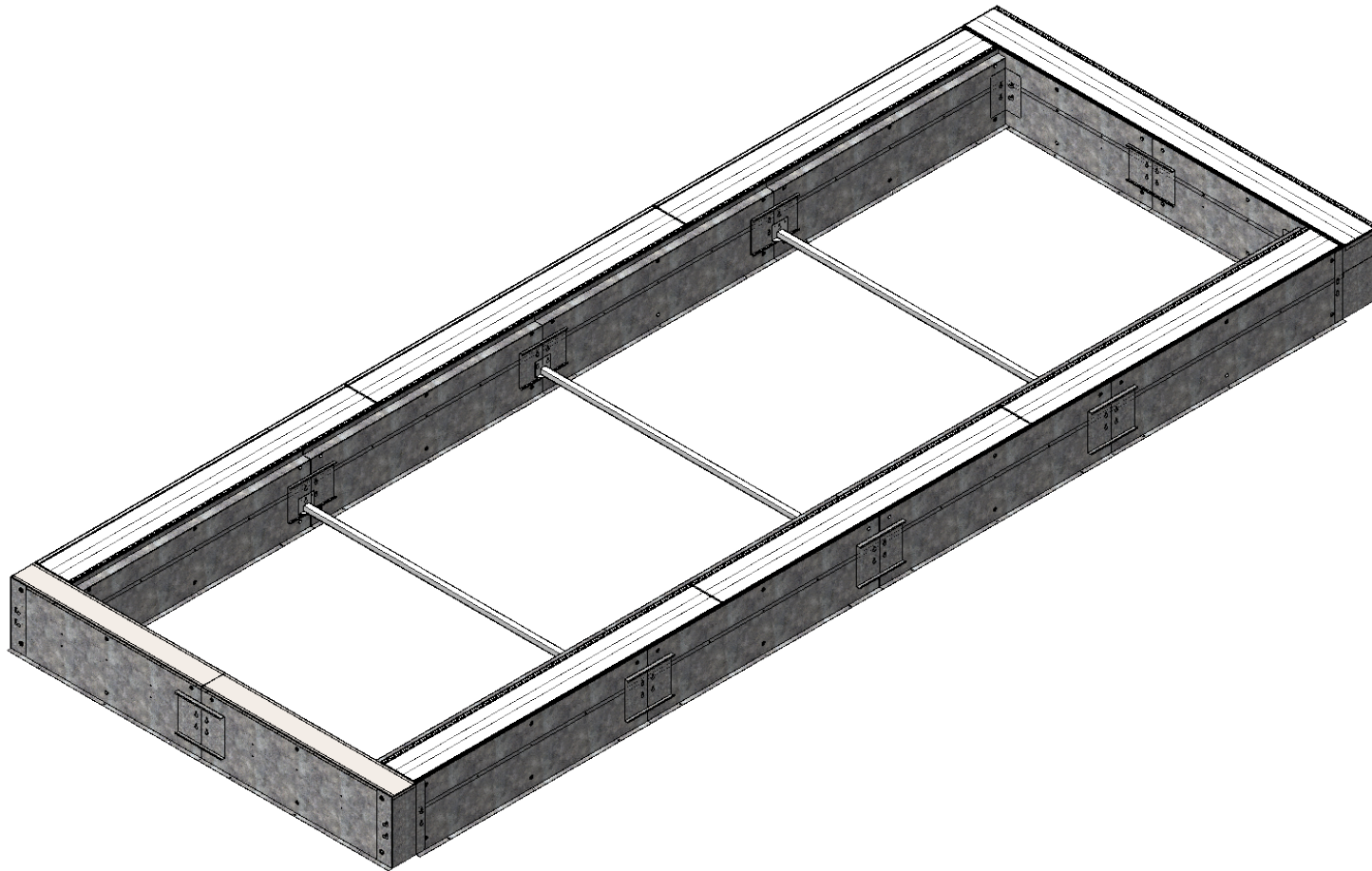

**Aluminum Athletic Equipment**  
1000 Enterprise Drive, Royersford, PA 19468  
Toll Free: (800) 523-5471 Fax: (610) 825-2378  
[www.AAEsports.com](http://www.AAEsports.com)

# PFS-NCAA-SC - NCAA Pit Form with Sand Catcher

## Long/Triple Jump Pit

### Layout Specifications

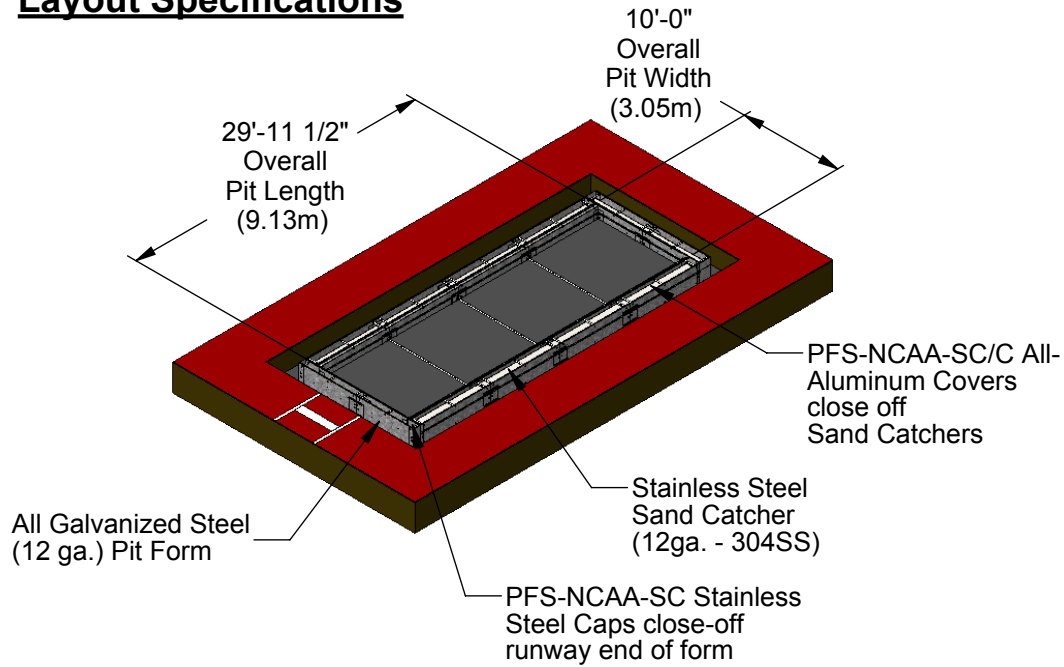

**Isometric View**

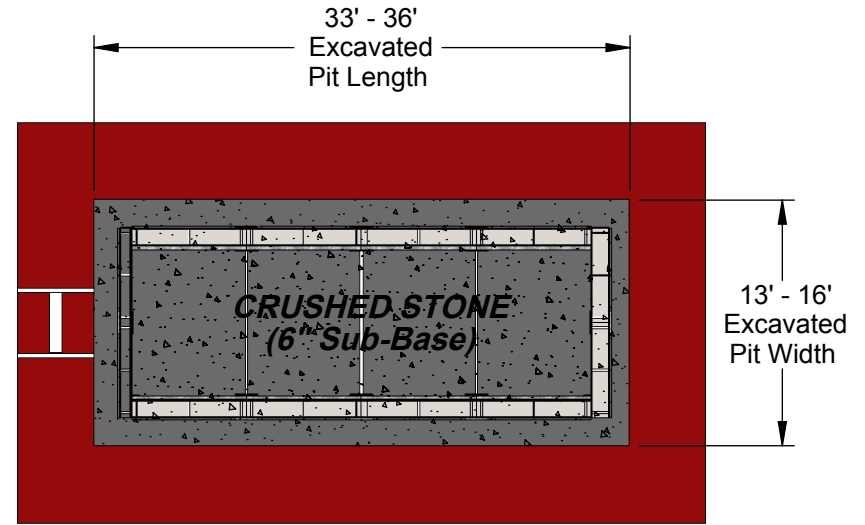

**Plan View**

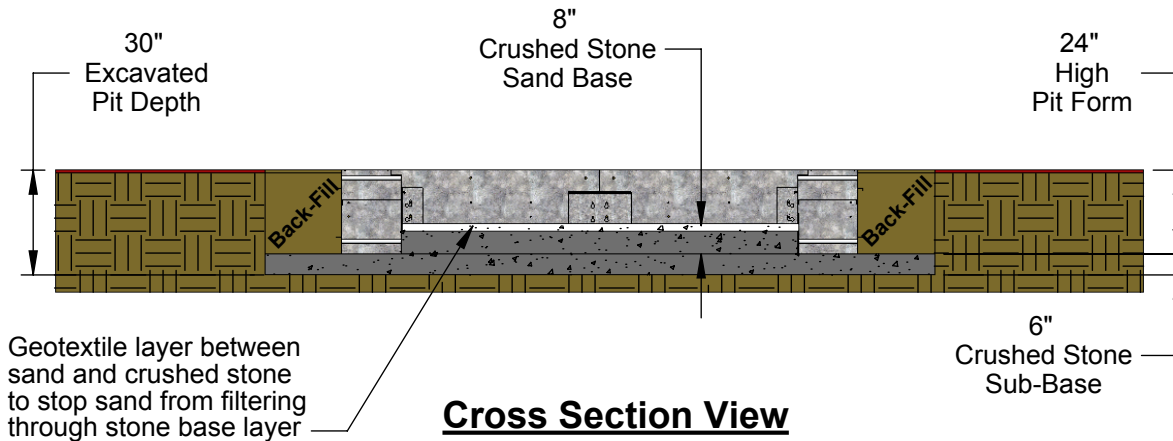

**Cross Section View**

 <p><b>Aluminum Athletic Equipment</b> 1000 Enterprise Drive, Royersford, PA 19468 Toll Free: (800) 523-5471 Fax: (610) 825-2378 www.AAEsports.com</p>		
DESCRIPTION: <b>PFS-NCAA-SC - NCAA Pit Form with Sand Catcher - Layout Specifications</b>		
NOTE: <b>Stainless Steel Pit Form Layout</b>		
MODEL: <b>PFS-NCAA-SC</b>	CATEGORY: <b>CUSTOMER</b>	DATE: <b>06/24/11</b>
DWN. BY: <b>ARP</b>	CAD FILE: <b>PFS-NCAA-SC Packet</b>	DWG. NO. <b>PFS-NCAA-SC-C-001</b>

# PFS-NCAA-SC Assembly

Corner Support Brackets (both inside and outside) slot into place over loosened bolts. Bolts are then tightened to firmly hold the form together

C-Channel Support Brackets (inside and outside of each flat joint) slot into place over loosened bolts. Bolts are then tightened to firmly hold the form together

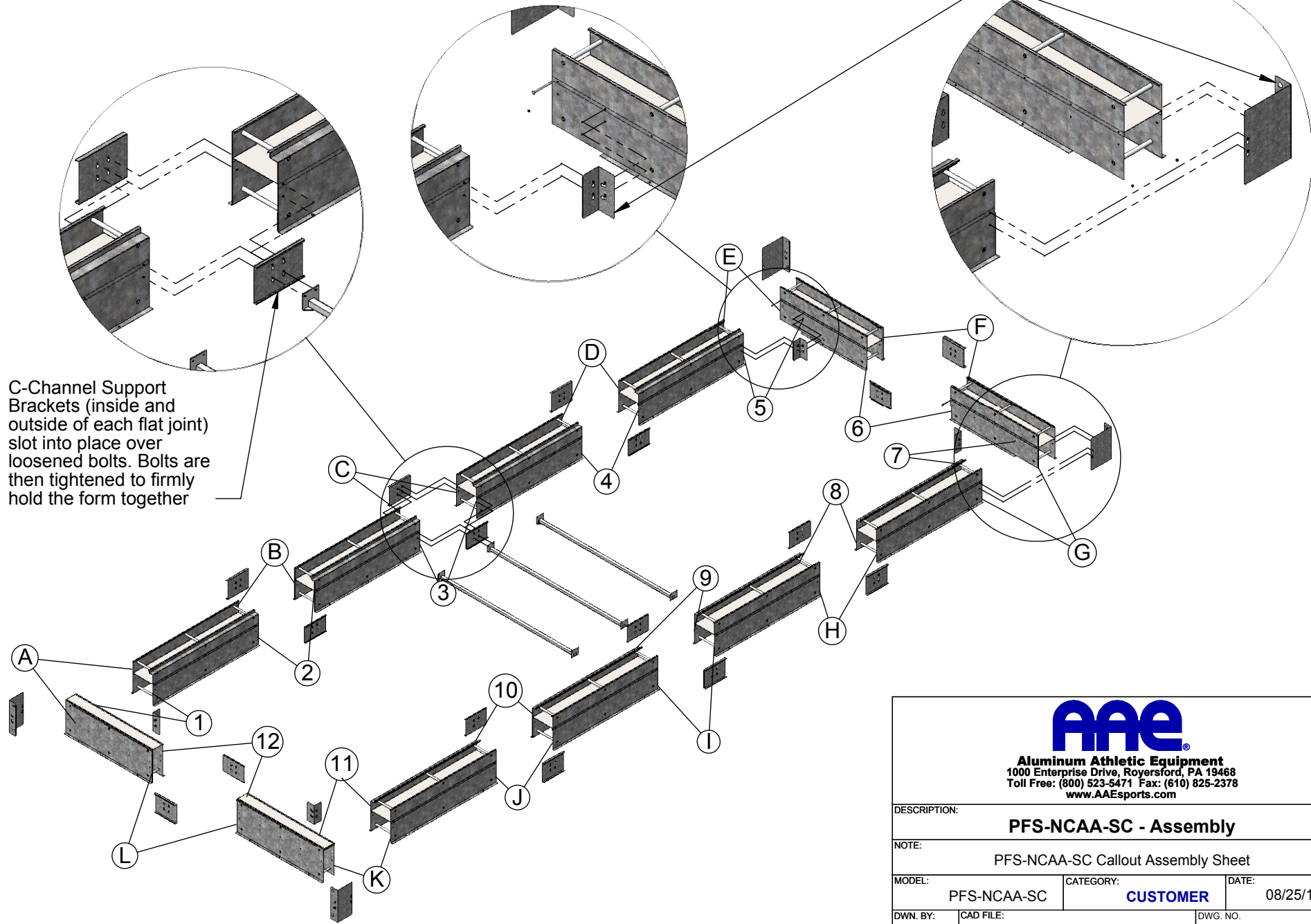

**Aluminum Athletic Equipment**  
1000 Enterprise Drive, Royersford, PA 19468  
Toll Free: (800) 523-5471 Fax: (610) 825-2378  
[www.AAEsports.com](http://www.AAEsports.com)

DESCRIPTION:		
<b>PFS-NCAA-SC - Assembly</b>		
NOTE: PFS-NCAA-SC Callout Assembly Sheet		
MODEL:	CATEGORY:	DATE:
PFS-NCAA-SC	<b>CUSTOMER</b>	08/25/11
DWN. BY:	CAD FILE:	DWG. NO.:
ARP	PFS-NCAA-SC Packet	PFS-NCAA-SC-C-002

# PFS-NCAA-SC Pit Form and Sand Catcher Details

Removable PFS-NCAA-SC/C Sand Catcher Covers (accept 10mm contractor-applied track surface)

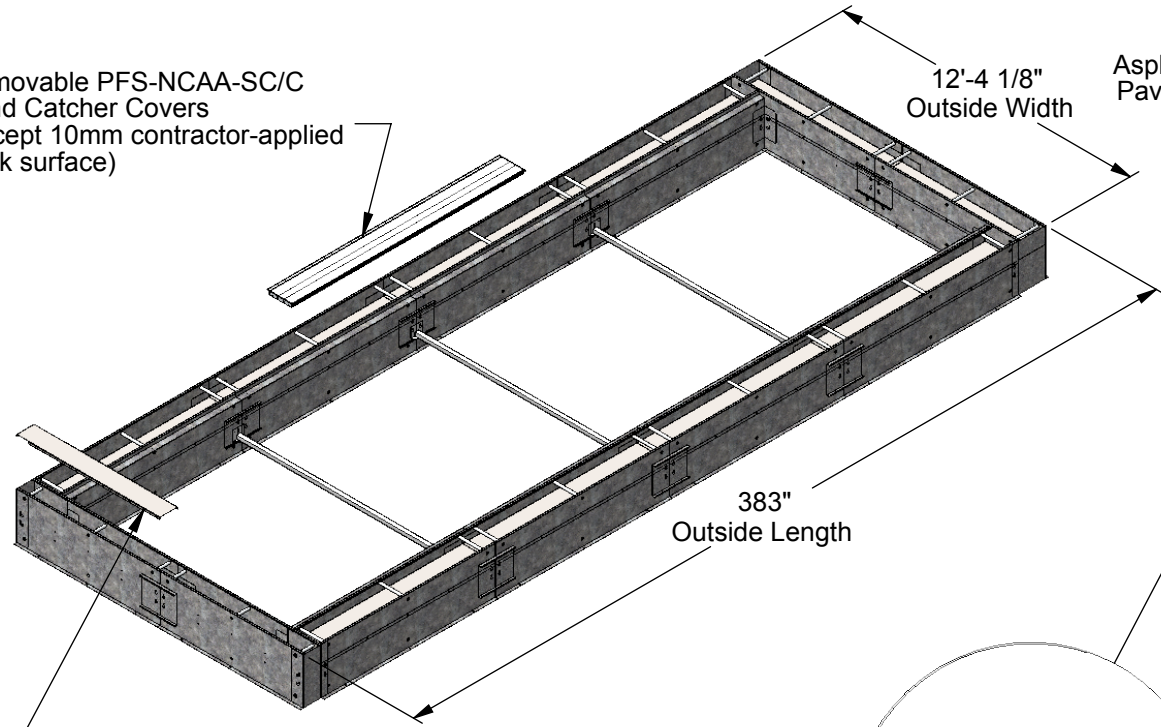

PFS-NCAA-SC Caps close off runway end of form

Asphalt flush with pit form top for 10mm track surface application (Recess asphalt 3mm below pit form top for 13mm track surface application)

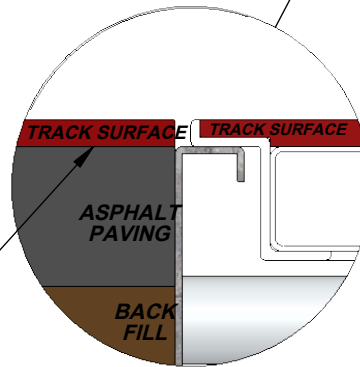

Asphalt Paving

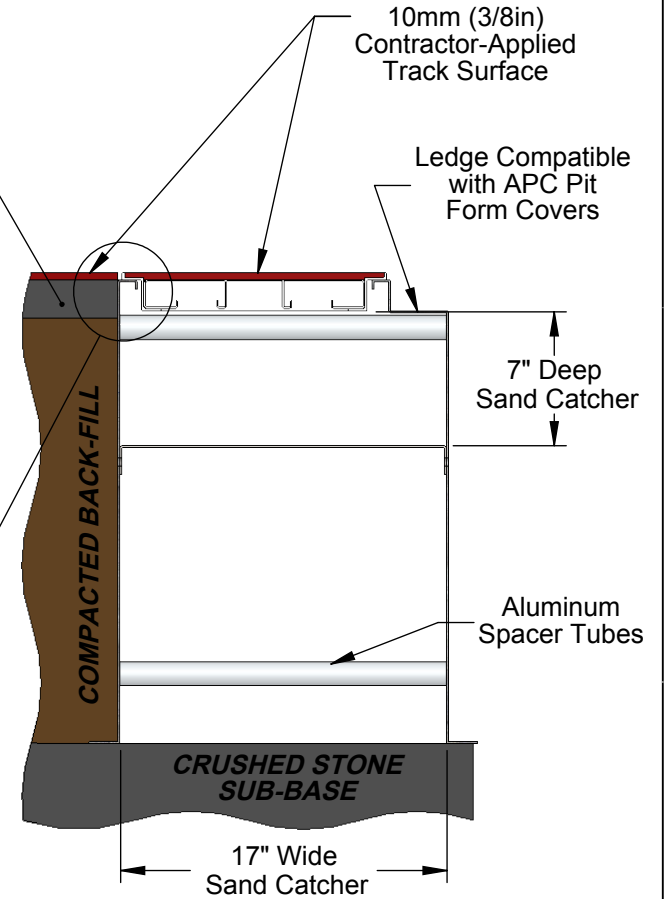

## Notes:

- No concrete required
- All Galvanized (12 ga.) pre-fabricated pit form
- Stainless Steel Sand Catcher (12 ga. - 304SS)
- All Aluminum (6061T6 Structural) Sand Catcher Covers
- Sections are shipped pre-assembled (10 sections)
- Overall Weight = 2,900 lbs



**Aluminum Athletic Equipment**  
1000 Enterprise Drive, Royersford, PA 19468  
Toll Free: (800) 523-5471 Fax: (610) 825-2378  
www.AAEsports.com

DESCRIPTION:		
<b>PFS-NCAA-SC - Pit Form Specifications</b>		
NOTE: Pit Form and Sand Catcher Details		
MODEL:	CATEGORY:	DATE:
PFS-NCAA-SC	<b>CUSTOMER</b>	06/24/11
DWN. BY:	CAD FILE:	DWG. NO.:
ARP	PFS-NCAA-SC Packet	PFS-NCAA-SC-C-002



# PFS-NCAA-SC Optional Features

Optional:  
Model No. PFS-NCAA-VSCT  
Vinyl Sand Catcher Tarp

- sold as a set of 2
- available in school colors
- captures sand thrown out of the pit during jumps
- can be easily lifted to return the sand to the pit after a jump
- all sides of pit except runway side equipped with sheet

Optional:  
Model No. APC  
Aluminum Pit Covers

- accepts 10mm (3/8in) contractor-applied track surface
- can be installed when pit is not in use

D

C

B

A

Vinyl Sand Catcher Tarp sized according to customer specifications

Model No. PFS-NCAA-VSCT  
Vinyl Sand Catcher Tarp

Removable aluminum cover

Pit Form

## Sand Catcher Compartment Detail

Vinyl Sand Catcher Tarp stores under Sand Catcher Covers when not in use.

Setup: remove Sand Catcher Covers, pull tarp over sand, reposition covers, and pull sheet back over covers off to the sides of the pit (shown above).  
Returning displaced sand to Pit: lift cover handles at each end, pull tarp over pit to replace the sand, then pull the tarp back to its previous position.  
After Use: pull sheet over sand, remove Sand Catcher Covers, fold or roll up tarp into sand catcher compartments, replace Sand Catcher Covers

Included w/ PFSNCAA-SC:  
Model No. PFS-NCAA-SC/C  
Sand Catcher Covers

- shown w/ 10mm (3/8in) contractor-applied track surface

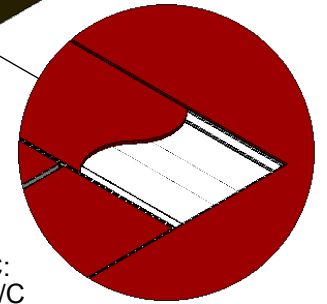

**Aluminum Athletic Equipment**  
1000 Enterprise Drive, Royersford, PA 19468  
Toll Free: (800) 523-5471 Fax: (610) 825-2378  
www.AAEsports.com

DESCRIPTION:		
<b>PFS-NCAA-SC - Optional Features</b>		
NOTE: Optional Features and Accessories		
MODEL:	CATEGORY:	DATE:
PFS-NCAA-SC	<b>CUSTOMER</b>	06/24/11
DWN. BY:	CAD FILE:	DWG. NO.:
ARP	PFS-NCAA-SC Packet	PFS-NCAA-SC-C-003